



**SAUNA  
INFRA CABIN**

2013

**SAUNA  
INFRA CABIN**

2013

# Table of contents

Sauna .....	10
Sauna room .....	12
Evolve .....	14
Impression .....	28
Impression Twin .....	30
Vision .....	34
Design room .....	36
Panorama .....	38
Sensation .....	40
Simplicity .....	42
Passion .....	44
Building a sauna .....	46
Backrests and benches E28 and E68 .....	48
Skirting panels, benches and backrests .....	50
Sauna panels, armrests, mouldings and types of wood .....	51
Sauna doors .....	52
DGL and DGB .....	53
DGM .....	54
DGP, DGR, DWG/DWB, Alu line, DGP, DW, door accessories .....	55
Glass panelling Evolve 9, Evolve 6, 52 and 52 vent .....	56
Sauna heaters .....	58
Sense .....	60
Combi and Compact .....	62
Expression .....	64
Sauna heater for professional use .....	66
TYLÖ Megaline, SDK and SD .....	67
Control panel h1 .....	68
Control panels EC50, CC300 and External switch .....	69
Wood-fired .....	70
Karhu, Karhu V/W, Saga .....	71
Sauna accessories .....	74
Infra .....	90
Infra cabin Prime+ .....	92





# Close your eyes, Open your senses

Step in and open your senses. Feel your thoughts clear and enjoy the calmness that spreads through your body. Your muscles relax, the tension is released. Your thoughts wonder, your dreams become reality. In the warmth the truth emerges, your soul is laid bare. We want to create the ultimate enjoyment that opens the door to what is inside you. This is our promise to you. Design and quality are our great passions; our Scandinavian designers set themselves the task of making the sauna environment an aesthetic exclamation mark. Ever since our founder Sven-Olof Janson built his first unit in the 1950s, we have been responsible for a series of ground-breaking innovations within saunas, showers and steam baths. Every little detail is infused with consideration and love. Open the door and feel, open your senses.





## Soft Sauna, as gentle on your skin as it sounds

We call it Soft Sauna, the new “soft way” of enjoying a sauna together. It is just as much a way of life as it is a technical sensation, and yet it takes up just a few square metres of space in your home. Invite your friends and family, select a therapeutic essential oil, let yourself be engulfed in the warmth and gentle steam, socialise and indulge together – let the benefits of Soft Sauna make an impression on your day.



Find out more about  
Tylo Soft Sauna at  
[www.tylo.com/softsauna](http://www.tylo.com/softsauna)

## A moment in the sauna, that goes beyond

Imagine having a family home spa with the resources of a professional spa in a space smaller than 1.3 m<sup>2</sup>, where you can relax together, exquisitely engulfed in steam and aromatic fragrances – and yet also be able to enjoy the relaxing dry heat of a traditional sauna. Choose the sauna cubicle and heater that suits you and the way you want your moment to be. A moment that stretches on and beyond.



## Enjoy softer warmth, your way

Our sauna heater is the heart and the key to how you can enjoy your home spa in several ways – exquisitely surrounded by gentle steam and aromatic fragrances, or traditionally in a relaxing dry sauna heat. Because how we want to enjoy our time in the sauna is a personal preference and depends on what we need at the moment, we designed our new combined sauna heater with a water tank and steam generator to handle all preferences. You can learn more about our Combi heater further on in this catalogue.



## What's your temperature?

Soft Sauna picks up where traditional saunas leave off. Some people prefer a hot and quick sauna; others prefer to linger for a longer period in mild temperatures to enjoy the gentle steam and aromatic fragrances. See here which temperatures and options are ideal for you and your moment.





# Tylarium™

Tylarium is Tylö's name for a range of sauna bath products that combine to produce a total well-being experience.



There's a Tylarium for most purposes. The basic idea is a combination of sauna and steam bath with a range of design and feature options. The heater and control panel below are an excellent choice for use in a Tylarium.



Steam generators Tylö VA



Heaters SD 16/SD 20



Control panel CC300T



## Steam sauna layout diagram

The heater and steam generator are operated from the control panel which can be installed in the reception area.

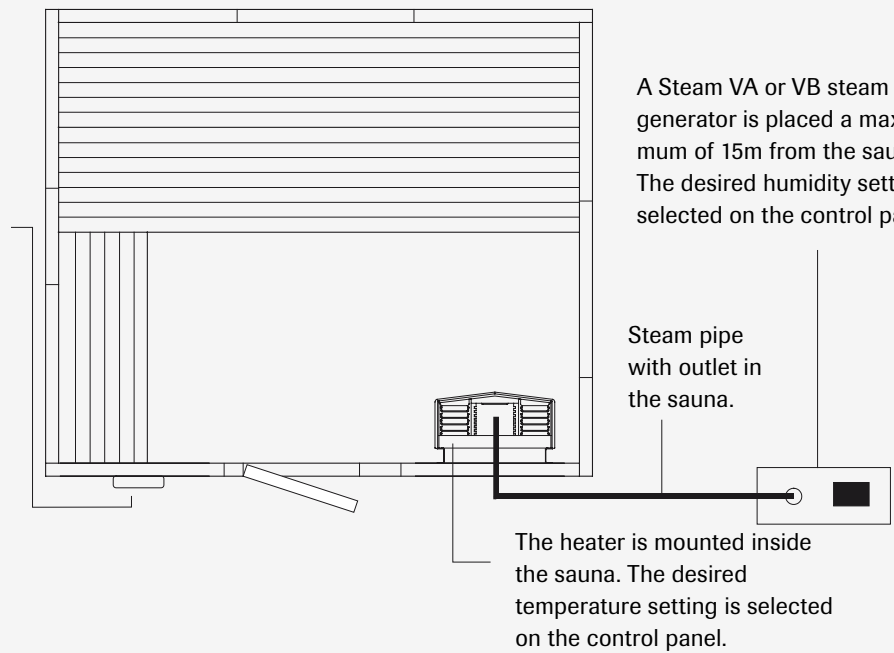

Sauna volume min/max m <sup>3</sup>	Heater type (kW)	Relay box	Steam generator type (kW)	Control panel
6 - 12	Sense SE 8 (8)	-	6 VA (6) or 6 VB (6.6)	CC 300T
10 - 18	SDK 10 (10.7 or Expression 10 (10)	RB 30	6 VA (6) or 6 VB (6.6)	
15 - 35	SD 16 (16)	RB 60	9 VA (9)	
22 - 43	SD 20 (20)	RB 60	12 VA (12)	



# Sauna

Sauna heaters

Sauna rooms

Design rooms

Wood-fired saunas

Sauna doors and interior fittings

Sauna accessories

Control panels

A sauna is total relaxation and cleansing for body and soul. As the world's leading sauna manufacturer, Tylö offers saunas, heaters and bespoke solutions.

Our complete range covers small saunas that fit your bathroom to exclusive saunas for larger facilities. The exceptional design and quality of Tylö's heaters set them apart.





# Sauna rooms

Planning to include a sauna when building a new property or renovating an existing one is simple – there is usually enough space. And it is even easier if you let us here at Tylö manufacture and deliver your sauna room as a prefabricated self-assembly package. We offer prefabricated sauna rooms in all variations, from small models adapted for the bathroom in your home, to large exclusive sauna rooms for hotel suites or corporate hospitality suites.





### Home spa from 1.3m<sup>2</sup>

A sauna is total relaxation and cleansing for body and soul. As the world's leading sauna manufacturer, Tylö offers saunas, heaters and bespoke solutions. Our complete range covers small saunas that fit your bathroom to exclusive saunas for larger facilities. The exceptional design and quality of Tylö's heaters set them apart.



Find out more at  
[www.tylo.com](http://www.tylo.com)

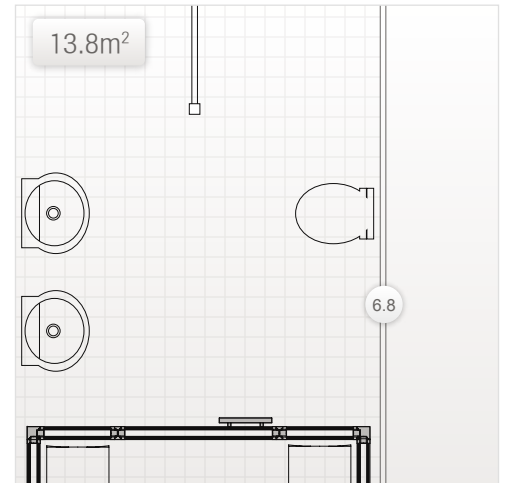

### Online tool

Let realistic bathroom visualisations inspire you. Select the type of bathroom and colour scheme you prefer and discover how easily you can make one of our saunas blend into your bathroom. This is an excellent tool if you are considering renovating or wondering how your bathroom could be transformed.



### Heat and steam

Choose one of our combination heaters for a perfect steam sauna solution. You can, of course, enjoy a traditional sauna with this heater too. The Compact 2/4 offers a simple yet functional solution for traditional sauna bathing.



# Evolve

## Close your eyes and spread your wings

As if by magic, the larva transforms into a chrysalis and then into a fully-formed butterfly. This process happens amazingly fast and the end result is perfection.

Evolve means to develop. We use the word to describe transition from one stage to another. A new form, function or intent. Rebirth, if you like. Transformation takes just four weeks for the monarch butterfly.



### What is an Evolve?

Tylö Evolve gives you almost unlimited versatility in customising your sauna to your own taste. Evolve is available in three basic versions with varying degrees of glass integration. The Flex system also allows you to extend the size in stages. On top of this you have a range of stylish optional extras and heaters for creating your own Evolve sauna, entirely tailored to your bathroom.





## Our new sauna is called Evolve for a reason

The name carries a unique meaning and Evolve is therefore no ordinary sauna. We bring you the best of both worlds for an unequalled sauna experience. The beautiful aspen interior with its genuine, luxurious feel harmonises with large glass panels and an open view of the bathroom.

Run your fingers over the hand-crafted aspen and drift into a relaxing reverie. Feel your inspiration awaken and your thoughts become clear. Close your eyes and spread your wings.

## A package solution or Flex?

Are you feeling creative or looking for a turnkey option?



Evolve brings you the best of both worlds - Package or Flex. Make quick and easy decisions or go for a more detailed approach.



# What is included in an Evolve?

Evolve Standard is the first step into the world of Evolve saunas with its authentic design and finish. It offers everything you need to experience true sauna pleasure in your own bathroom. Pre-insulated walls/ceiling, floor frame and ventilation with an unrivalled standard of craftsmanship throughout.

If you want a more open feel with larger glass panels, Evolve Plus GF or Evolve Plus GC are the answers.

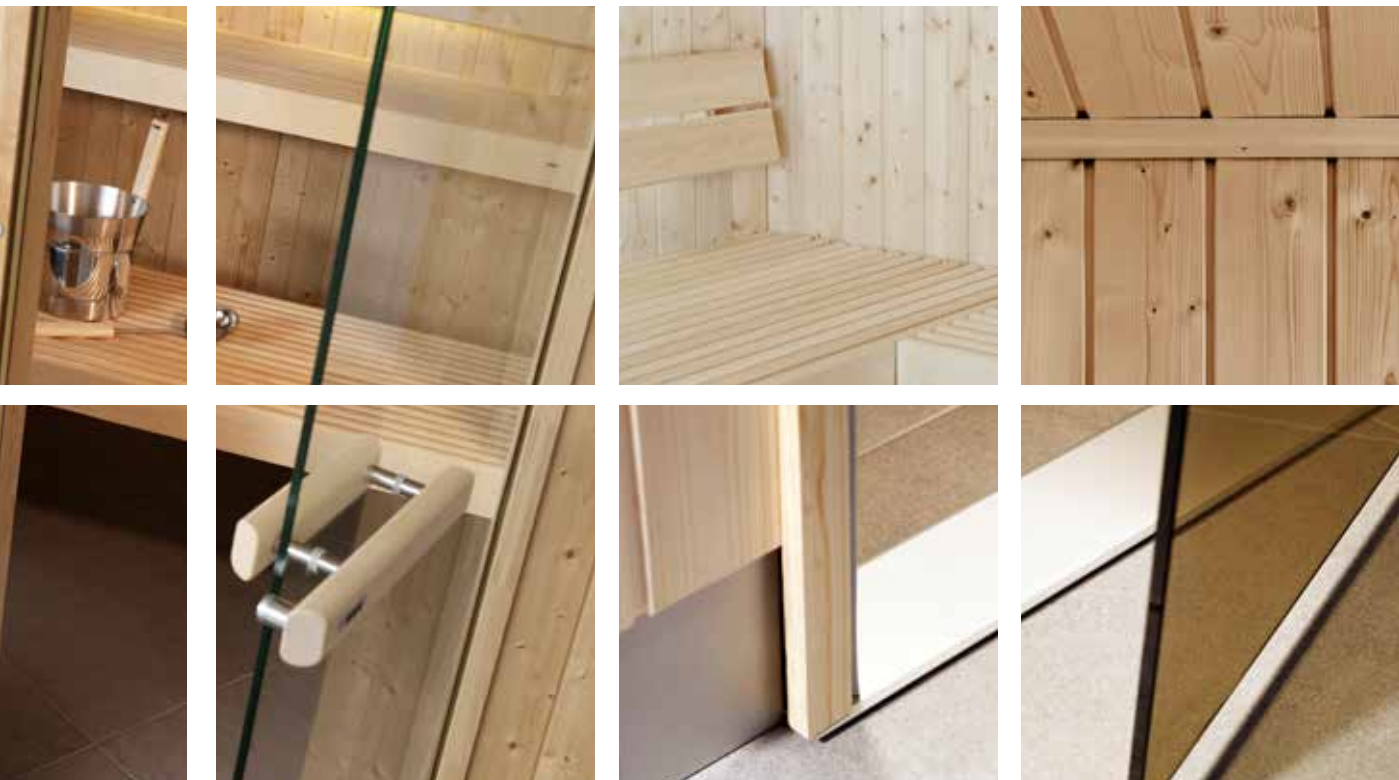

<b>Your Evolve includes the following:</b>	<b>Standard</b>	<b>Plus GF</b>	<b>Plus GC</b>
Aluminium floor frame	■	■	■
Vent and assembly hardware	■	■	■
Insulated wall and ceiling panels	■	■	■
Additional glass panel	○	-	-
Frameless glass panel	-	■	-
Frameless corner glass panel	-	-	■

■ = included    ○ = optional    - = not optional

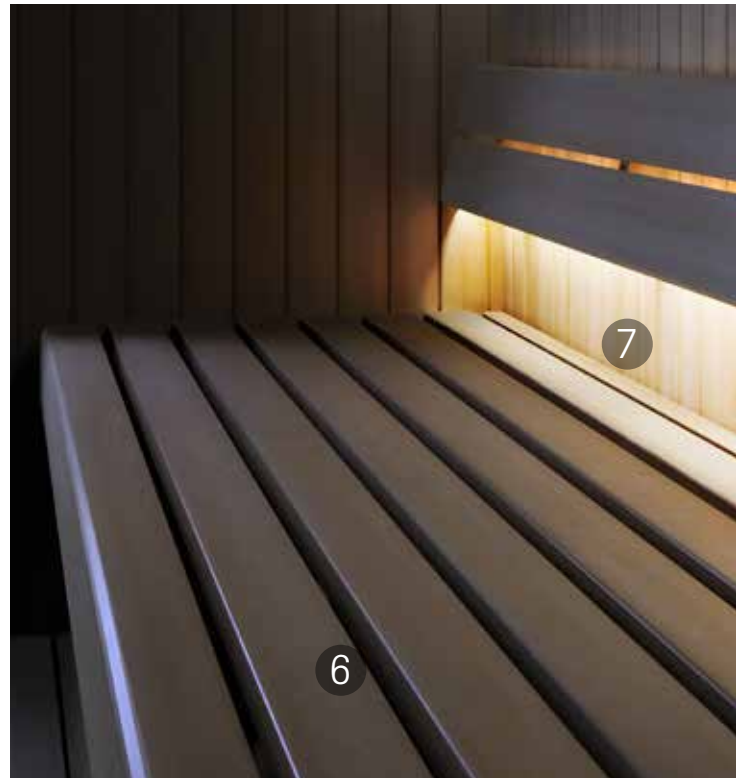

**1.** DGB is a simple yet robust spruce sauna door. **2.** DGL is a series of more exclusive sauna doors, made from aspen. The glass doors in a sauna package are always clear. Tinted glass is available as an option. **3.** Spruce. **4.** Aspen. **5.** The E28 sauna bench has narrow slats made from solid aspen. **6.** The E68 sauna bench has wide slats made from solid aspen. Both benches are crafted without visible screws. **7.** Sauna LED lighting.

# Evolve Standard

The feel of quality and genuine craftsmanship are immediately apparent. First, you choose whether to have spruce or aspen panels, then vertical or horizontal bench slats. The sauna door is included and is available in a variety of designs.

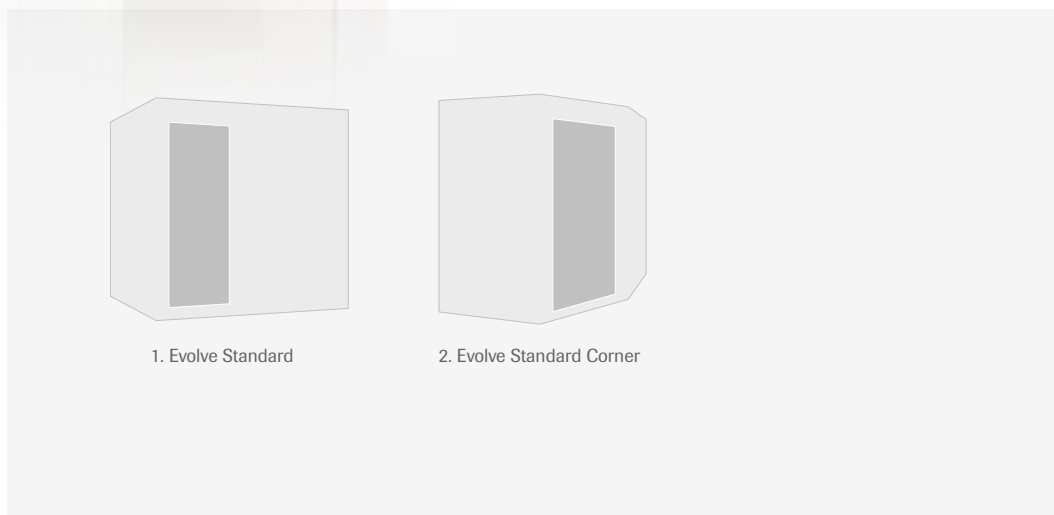

1. Evolve Standard

2. Evolve Standard Corner



# Evolve Plus

Larger glass panels increase the sense of openness. **Evolve Plus GF**, which stands for Glass Front, gives the sauna a much greater glazed area. If you like openness and natural light flooding in, then Evolve Plus GF will appeal.

**Evolve Plus GC** stands for Glass Corner and offers you maximum vistas while relaxing in the sauna. The highly exclusive Plus GC sauna promises an exquisite experience with its expansive glazed design. If your bathroom is spacious and beautiful, the dimensions of the Plus GC will really come into their own.

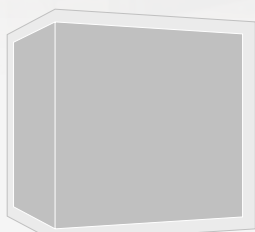

1. Evolve Plus GC

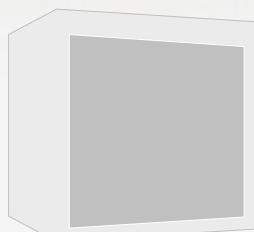

2. Evolve Plus GF





# Package solution

Of course you want to spend more time enjoying your sauna. Our complete packages make choosing and owning a sauna a simple experience.

We offer three Evolve packages complete with everything needed, from the lighting to the heater.



How to order a package

### Step 1

Choose a package  
Mini, Midi, Maxi.



### Step 2

Choose from  
Standard/GF/GC.



### Step 3

Choose a  
heater.

In just three easy steps, you choose the size, interior, lighting, door and heater to create an Evolve sauna tailored to your needs and taste.

Nothing could be easier and it saves you precious time. Time better spent relaxing in your sauna.



#### Enhance the experience

The Sense Combi crossover heater adds variation to your pleasure. Enjoy dry, wet and steam saunas with just one heater, which features a standby mode and divided output to maximise energy efficiency.

The elegant h2 control panel is also included in its design.



<b>Art. no. for Evolve</b>	Mini 1430 x 1430 mm (width x depth)	Midi 1685 x 1685 mm (width x depth)	Maxi 2195 x 1940 mm (width x depth)
<b>Standard Gran</b> INTERIOR E68 SAUNA DOOR DGB SAUNA LED LIGHTING	<b>9510 6300</b>	<b>9510 6302</b>	<b>9510 6304</b>
<b>Standard Asp</b> INTERIOR E28 SAUNA DOOR DGL SAUNA LED LIGHTING	<b>9510 6330</b>	<b>9510 6332</b>	<b>9510 6334</b>
<b>Standard Corner Gran</b> INTERIOR E68 SAUNA DOOR DGB SAUNA LED LIGHTING	<b>9510 6310</b>	<b>9510 6312</b>	<b>9510 6314</b>
<b>Standard Corner Asp</b> INTERIOR E28 SAUNA DOOR DGL SAUNA LED LIGHTING	<b>9510 6340</b>	<b>9510 6342</b>	<b>9510 6344</b>
<b>Plus GF Gran</b> INTERIOR E68 SAUNA DOOR DGL PLUS SAUNA LED LIGHTING	<b>9510 6320</b>	<b>9510 6322</b>	<b>9510 6324</b>
<b>Plus GF Asp</b> INTERIOR E28 SAUNA DOOR DGL PLUS SAUNA LED LIGHTING	<b>9510 6350</b>	<b>9510 6352</b>	<b>9510 6354</b>
<b>Plus GC Asp Left</b> INTERIOR E28 SAUNA DOOR DGL PLUS SAUNA LED LIGHTING	-	<b>9510 6362</b>	<b>9510 6364</b>
<b>Plus GC Asp Right</b> INTERIOR E28 SAUNA DOOR DGL PLUS SAUNA LED LIGHTING	-	<b>9510 6363</b>	<b>9510 6365</b>

# Flex

Materials, fittings, the door and lights - don't you just love choosing? You are careful in making your choices and see the benefits of customising a solution for your bathroom.



Honeycombs are nature's own Flex system. Bees construct new comb cells at lightning speed. As many as 4000 a day in larger colonies.

Our Flex system guarantees that the Evolve is designed exactly to your wishes and delivers the experience you're seeking.

Choose from a range of fittings, lights, woods and doors with a matching heater to complete the design.

Follow our four steps to create your own, personal Evolve sauna, then enjoy an absolutely unique experience.



reddot design award

### Award-winning design

The Expression Combi heater takes everything to a new level. This heater lets you enjoy a dry, wet and steam sauna.

Expression has won the international Red Dot Design award.

How to order Evolve Flex.

### Step 1

Choose a size. Width, depth and height.



### Step 2

Choose from Standard/GF/GC.



### Step 3

Choose wood, interior fittings, door & light.



### Step 4

Choose a heater.



## Evolve Standard & Evolve Corner

- External height: 2100 mm with high floor frame and 2010 mm with low floor frame.
- Can be reversed.
- Choose either aspen or spruce panelling.
- Saunas 2195 to 2705 mm in width are fitted with a third bench.
- Can also be fitted with glass panelling. Contact your dealer for details.

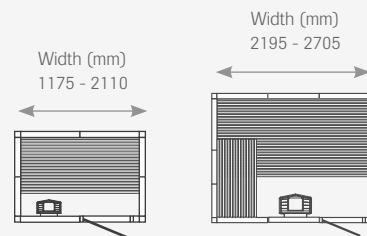

Width		1175	1255	1340	1430	1510	1600	1685	1770	1855	1940	2020	2110	2195	2280	2365	2450	2535	2620	2705	
Depth	1175	■	○	○	○	○	○	■	○	○	○	○	○	○	○	○	○	○	○	○	○
	1430	○	○	○	■	○	○	○	○	○	○	○	○	○	○	○	○	○	○	○	○
	1685	○	○	○	○	○	○	■	○	○	■	○	○	■	○	○	○	○	○	○	○
	1940	○	○	○	○	○	○	○	○	○	■	○	○	■	○	○	■	○	○	○	■
	2195	○	○	○	○	○	○	○	○	○	○	○	○	■	○	○	■	○	○	○	○

■ = layout shown on the next page.

○ = available in this design.

— = not available in this design.

## Evolve Plus GF

- External height: 2100 mm with high floor frame and 2010 mm with low floor frame.
- Can be reversed.
- Choose either aspen or spruce panelling.
- Saunas 1175 to 1430 mm in depth are fitted with a movable bench.

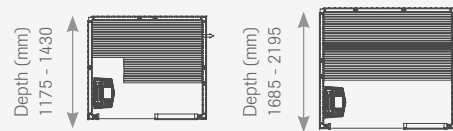
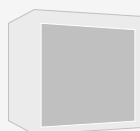

Width		1175	1255	1340	1430	1510	1600	1685	1770	1855	1940	2020	2110	2195	2280	2365	2450	2535	2620	2705	
Depth	1175	—	—	—	○	○	—	■	○	○	○	○	○	○	○	○	○	○	○	○	○
	1430	—	—	—	■	○	—	○	○	○	○	○	○	○	○	○	○	○	○	○	○
	1685	—	—	—	○	○	—	■	○	○	■	○	○	■	○	○	○	○	○	○	○
	1940	—	—	—	○	○	—	○	○	○	■	○	○	■	○	○	■	○	○	○	■
	2195	—	—	—	○	○	—	○	○	○	○	○	○	■	○	○	■	○	○	○	○

■ = layout shown on the next page.

○ = available in this design.

— = not available in this design.

## Evolve Plus GC

- External height: 2100 mm with high floor frame.
- Available in right and left models.
- Saunas 2450 to 2705 mm in depth are fitted with a movable bench.

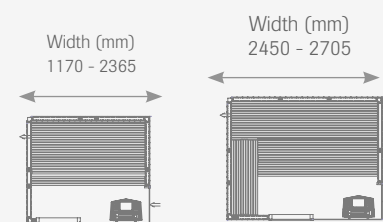
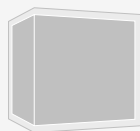

Width		1175	1255	1340	1430	1510	1600	1685	1770	1855	1940	2020	2110	2195	2280	2365	2450	2535	2620	2705	
Depth	1175	—	—	—	—	—	—	■	—	—	○	○	○	○	○	○	○	○	○	○	○
	1430	—	—	—	—	—	—	○	—	—	○	○	○	○	○	○	○	○	○	○	○
	1685	—	—	—	—	—	—	■	—	—	■	○	○	■	○	○	○	○	○	○	○
	1940	—	—	—	—	—	—	○	—	—	■	○	○	■	○	○	■	○	○	○	■
	2195	—	—	—	—	—	—	○	—	—	○	○	○	■	○	○	■	○	○	○	○

■ = layout shown on the next page.

○ = available in this design.

— = not available in this design.





# Your freedom of choice is part of our design plans

Here is a layout chart of our complete range of prefabricated sauna rooms. It shows the sizes, correct location of the sauna heater and the layout of the interior fittings. Reverse installation is possible for the Standard and Plus GF saunas. It also indicates which standard walls can be replaced by glass panelling.

For the sake of clarity, the optimum heater output for each sauna is also specified. All you do now is compare the details and decide which sauna you like most.

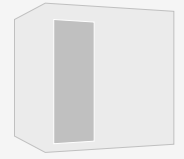

## Evolve Standard

All the saunas have an external height of 2100 mm with the high floor frame (standard) and 2010 mm with the low floor frame.

- Glass panelling 9L & Glass panelling 9H
- Glass panelling 6L & Glass panelling 6H
- Glass panelling 9L/V & Glass panelling 9H/V (vent)
- Glass panelling 6L/V & Glass panelling 6H/V (vent)

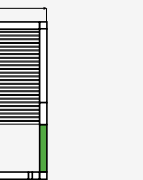
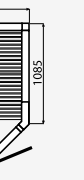
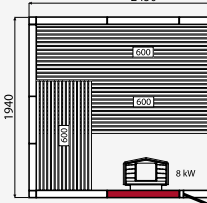
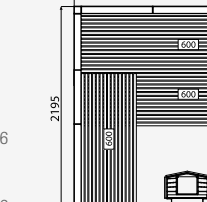
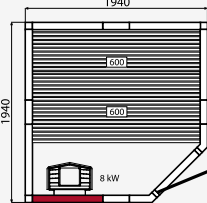
 E1212 SPRUCE Art. no. 9510 6400	 E1212 ASPEN Art. no. 9510 6500	 E1712 SPRUCE Art. no. 9510 6406	 E1712 ASPEN Art. no. 9510 6506	 E1414 SPRUCE Art. no. 9510 6402	 E1414 ASPEN Art. no. 9510 6502	 E1414/c SPRUCE Art. no. 9510 6404	 E1414/c ASPEN Art. no. 9510 6504
 E1717 SPRUCE Art. no. 9510 6408	 E1717 ASPEN Art. no. 9510 6508	 E1917 SPRUCE Art. no. 9510 6412	 E1917 ASPEN Art. no. 9510 6512	 E2217 SPRUCE Art. no. 9510 6420	 E2217 ASPEN Art. no. 9510 6520	 E1717/c SPRUCE Art. no. 9510 6410	 E1717/c ASPEN Art. no. 9510 6510
 E1919 SPRUCE Art. no. 9510 6416	 E1919 ASPEN Art. no. 9510 6516	 E2219 SPRUCE Art. no. 9510 6422	 E2219 ASPEN Art. no. 9510 6522	 E2419 SPRUCE Art. no. 9510 6428	 E2419 ASPEN Art. no. 9510 6528		
 E2719 SPRUCE Art. no. 9510 6432	 E2719 ASPEN Art. no. 9510 6532	 E2222 SPRUCE Art. no. 9510 6426	 E2222 ASPEN Art. no. 9510 6526	 E2422 SPRUCE Art. no. 9510 6430	 E2422 ASPEN Art. no. 9510 6530		
 E1917/c SPRUCE Art. no. 9510 6414	 E1917/c ASPEN Art. no. 9510 6514	 E1919/c SPRUCE Art. no. 9510 6418	 E1919/c ASPEN Art. no. 9510 6518	 E2219/c SPRUCE Art. no. 9510 6424	 E2219/c ASPEN Art. no. 9510 6524		

## Evolve Plus GF

All the saunas have an external height of 2100 mm with the high floor frame (standard) and 2010 mm with the low floor frame.

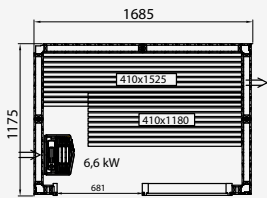
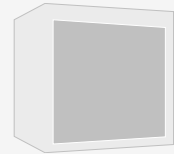

E1712 PLUS GF  
SPRUCE  
Art. no. 9510 6612

E1712 PLUS GF ASPEN  
Art. no. 9510 6652

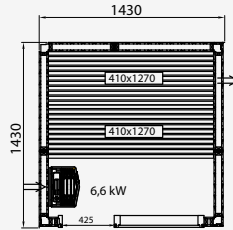

E1414 PLUS GF  
SPRUCE  
Art. no. 9510 6610

E1414 PLUS GF ASPEN  
Art. no. 9510 6650

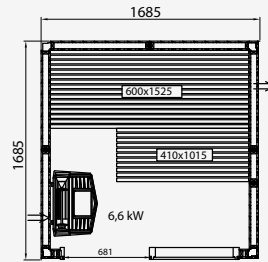

E1717 PLUS GF  
SPRUCE  
Art. no. 9510 6614

E1717 PLUS GF ASPEN  
Art. no. 9510 6654

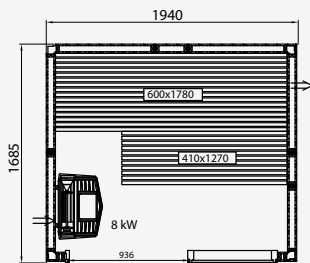

E1917 PLUS GF  
SPRUCE  
Art. no. 9510 6616

E1917 PLUS GF ASPEN  
Art. no. 9510 6656

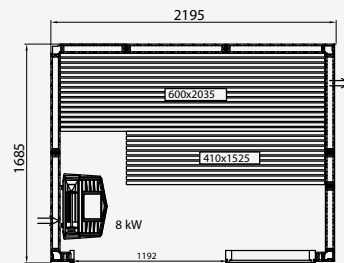

E2217 PLUS GF  
SPRUCE  
Art. no. 9510 6620

E2217 PLUS GF ASPEN  
Art. no. 9510 6660

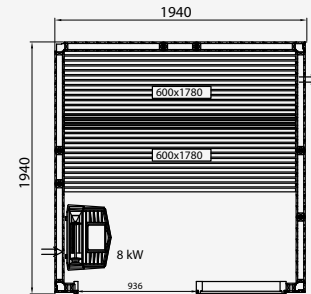

E1919 PLUS GF  
SPRUCE  
Art. no. 9510 6618

E1919 PLUS GF ASPEN  
Art. no. 9510 6658

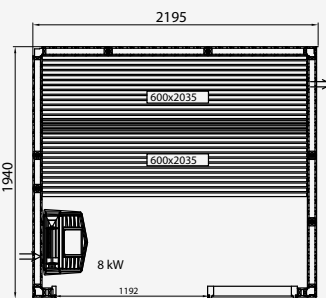

E2219 PLUS GF  
SPRUCE  
Art. no. 9510 6622

E2219 PLUS GF ASPEN  
Art. no. 9510 6662

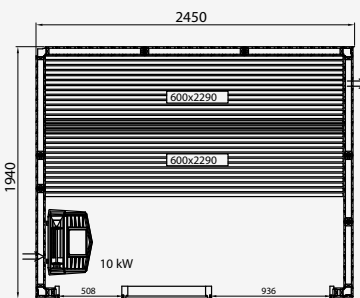

E2419 PLUS GF  
SPRUCE  
Art. no. 9510 6626

E2419 PLUS GF ASPEN  
Art. no. 9510 6666

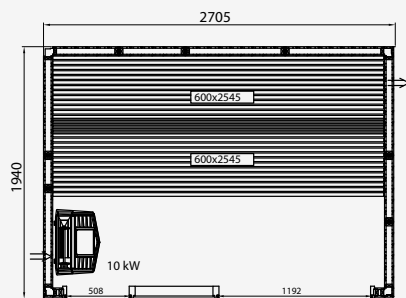

E2719 PLUS GF  
SPRUCE  
Art. no. 9510 6630

E2719 PLUS GF ASPEN  
Art. no. 9510 6670

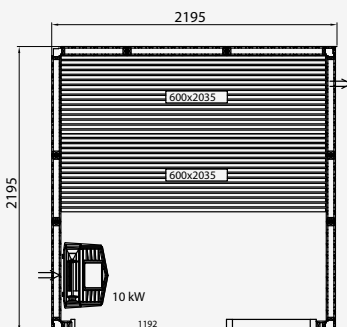

E2222 PLUS GF  
SPRUCE  
Art. no. 9510 6624

E2222 PLUS GF ASPEN  
Art. no. 9510 6664

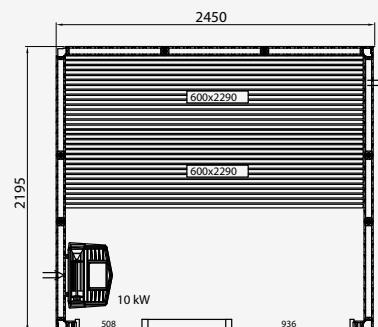

E2422 PLUS GF  
SPRUCE  
Art. no. 9510 6628

E2422 PLUS GF ASPEN  
Art. no. 9510 6668

## Evolve Plus GC

All the saunas have an external height of 2100 mm.

**RIGHT** means that the sauna is best placed in the right-hand corner of the bathroom.

**LEFT** means that the sauna is best placed in the left-hand corner of the bathroom.

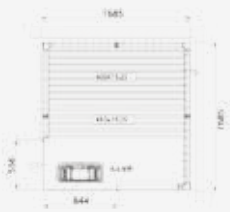
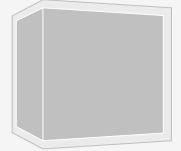

**E1717 PLUS GC RIGHT**  
Art. no. 9510 6711



**E1717 PLUS GC LEFT**  
Art. no. 9510 6710

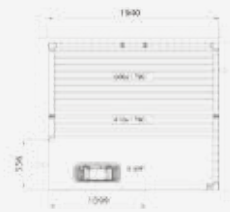

**E1917 PLUS GC RIGHT**  
Art. no. 9510 6713

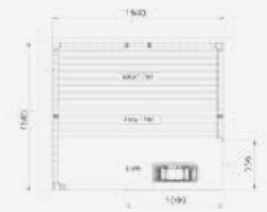

**E1917 PLUS GC LEFT**  
Art. no. 9510 6712



**E2217 PLUS GC RIGHT**  
Art. no. 9510 6717

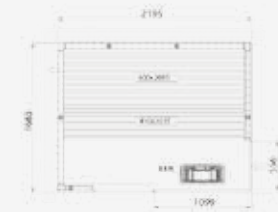

**E2217 PLUS GC LEFT**  
Art. no. 9510 6716

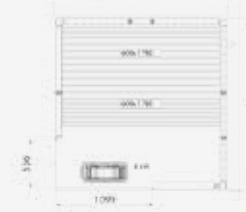

**E1919 PLUS GC RIGHT**  
Art. no. 9510 6715



**E1919 PLUS GC LEFT**  
Art. no. 9510 6714

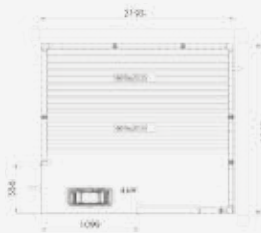

**E2219 PLUS GC RIGHT**  
Art. no. 9510 6719

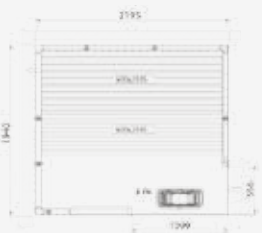

**E2219 PLUS GC LEFT**  
Art. no. 9510 6718

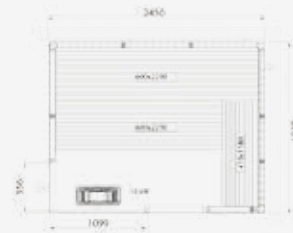

**E2419 PLUS GC RIGHT**  
Art. no. 9510 6723



**E2419 PLUS GC LEFT**  
Art. no. 9510 6722

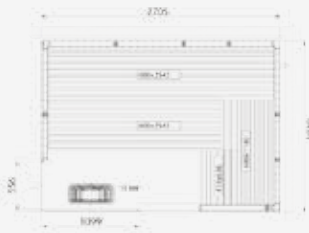

**E2719 PLUS GC RIGHT**  
Art. no. 9510 6727

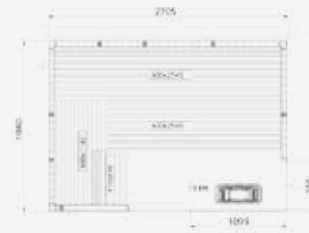

**E2719 PLUS GC LEFT**  
Art. no. 9510 6726



**E2222 PLUS GC RIGHT**  
Art. no. 9510 6721

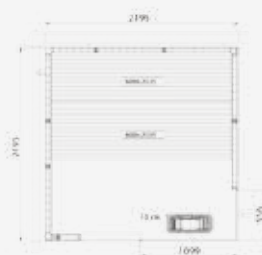

**E2222 PLUS GC LEFT**  
Art. no. 9510 6720

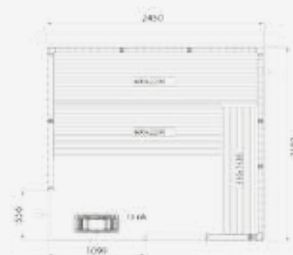

**E2422 PLUS GC RIGHT**  
Art. no. 9510 6725

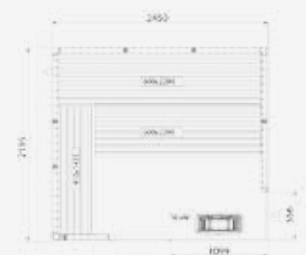

**E2422 PLUS GC LEFT**  
Art. no. 9510 6724



## Impression sauna rooms



Find out more at  
[www.tylo.com](http://www.tylo.com)

Tylö's new Impression sauna range takes up a minimal amount of space from as little as 1.3 m<sup>2</sup>. This sauna solution can contain both a traditional sauna and a gentler steam sauna. It's a revolution in home spa design, compact enough to fit in even a small bathroom.

The sauna cubicle comes complete with two sauna benches at different levels. The lacquered aluminium profiles of the frame conform to a registered design that ensures maximum versatility within the unique Tylo system. They simply clip together, so no screws are needed for assembly. The sleek lines of the design and the detachable jalousie are a joy to behold – and simplicity itself to clean.



## Style-conscious choice



1



3



2



4

1. Accessory Dark 2. Tylö textile 3. Combi Compact 4 heater. 4. Natural essence oils.

This is how  
to order a  
complete  
Impression

### Step 1

Measure your  
bathroom



### Step 2

Select a  
heater & size



### Step 3

Contact your  
dealer

### Included:

- Insulated walls
- Ceiling section
- Door section
- Aspen and ash interior
- Backrest
- Lighting
- Hygrometer/Thermometer
- Aluminium floor frame
- Blinds\*
- Corner and ceiling mouldings
- Vents and assembly hardware

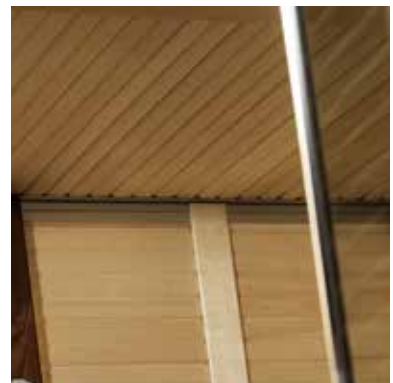

\*Can be sold separately. Art. no. 9607 4785



# Impression Twin



Find out more at  
[www.tylo.com](http://www.tylo.com)

Tylö has combined a sauna and steam shower to create an exciting new wellness product for greater relaxation. The design and materials exude a palpable feeling of luxury. A shower, extra bench and a number of accessories add greater variation to the sauna room.

A hot tip: the perfect way to relax after a home gym workout is to combine a sauna and steam shower. Impression Twin really gives you the best of both worlds.

How to order a complete Impression

**Step 1**

Measure your bathroom



**Step 2**

Select a heater & size



**Step 3**

Contact your dealer

**Included:**

- Insulated wall and ceiling panels
- Doors
- Shower column including mixer tap
- Steam generator
- Sauna section including panels and benches
- Aspen and dark, heat-treated ash interior
- Shower section lighting
- Light strip hygro/thermo
- Aluminium floor frame
- Corner and ceiling mouldings
- Vents and assembly hardware

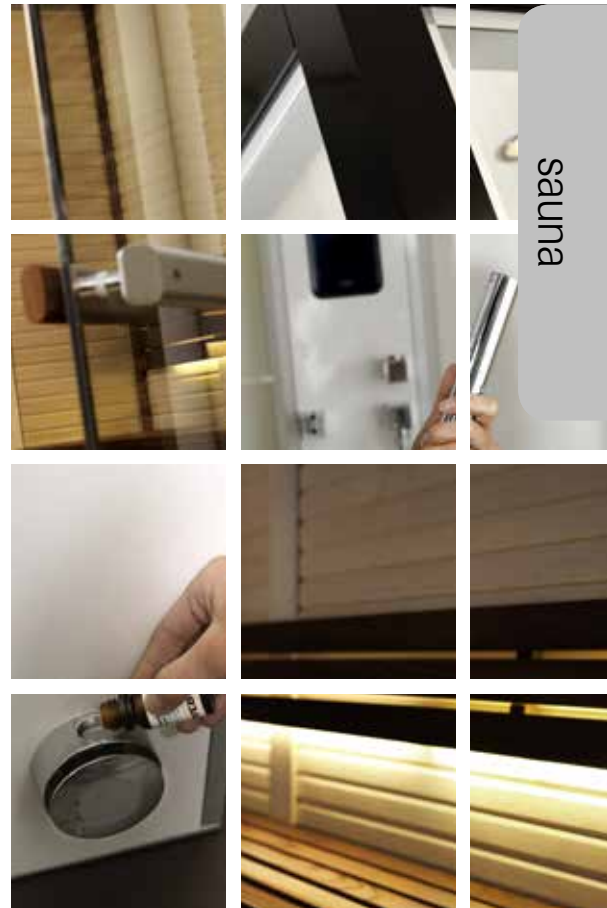

sauna

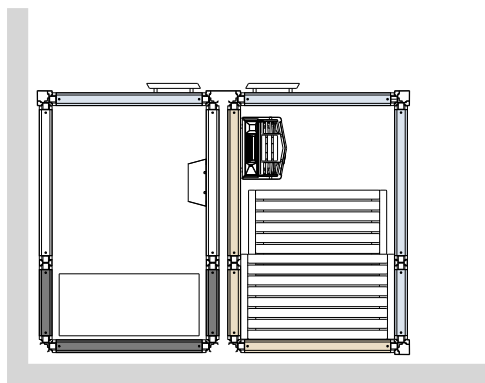

Please see the next page for more configuration suggestions

**A flexible system**

Walls, glass sections and doors can be assembled in a variety of different ways to suit your bathroom layout. You can also place all interior fittings – except for the sauna heater – where you wish. Here is an example of a common configuration.

**Style-conscious choice**

- 1.** Combi 4
- 2.** Bucket & stainless steel ladle with wooden handle
- 3.** An extra bench, white i44 or i66



# Impression sauna

(Outer ceiling height 2100 mm)

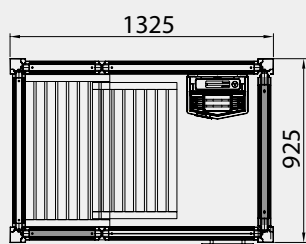

**Impression sauna i1309**  
 White: Art. no. 9607 4815  
 Black: Art. no. 9607 4817

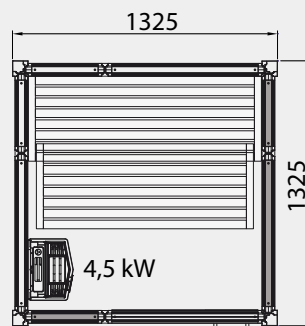

**Impression sauna i1313**  
 White: Art. no. 9607 4820  
 Black: Art. no. 9607 4822

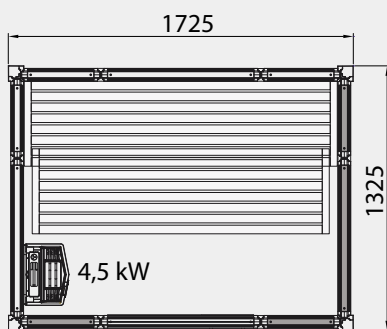

**Impression sauna i1713**  
 White: Art. no. 9607 4825  
 Black: Art. no. 9607 4827

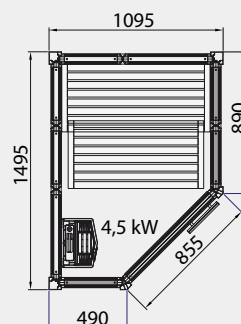

**Impression sauna i1115/c**  
 White: Art. no. 9607 4800  
 Black: Art. no. 9607 4802

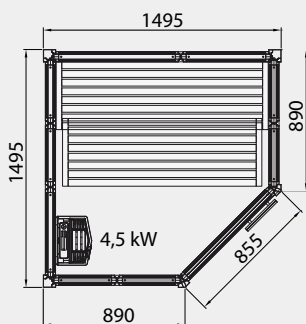

**Impression sauna i1515/c**  
 White: Art. no. 9607 4805  
 Black: Art. no. 9607 4807

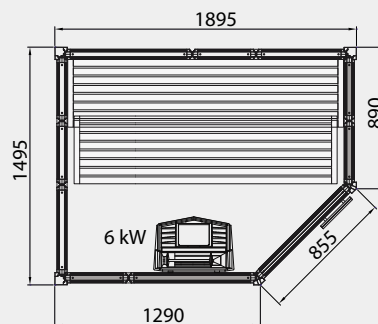

**Impression sauna i1915/c**  
 White: Art. no. 9607 4810  
 Black: Art. no. 9607 4812



## Impression Twin

Outer ceiling height 2100 mm  
All rooms can be reversed

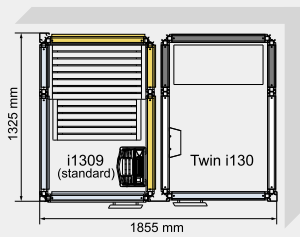
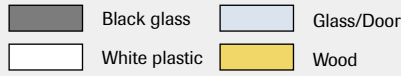

**TWIN 130/1309**  
White Art. no. 9607 4840  
Black Art. no. 9607 4841

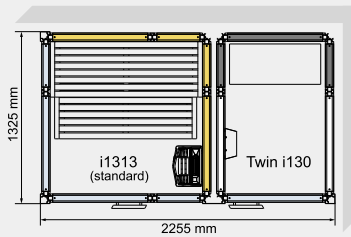

**TWIN 130/1313**  
White Art. no. 9607 4842  
Black Art. no. 9607 4843

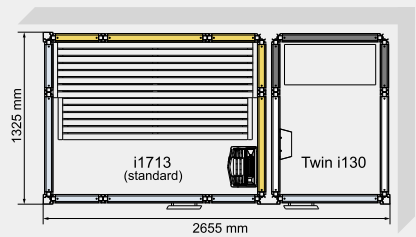

**TWIN 130/1713**  
White Art. no. 9607 4844  
Black Art. no. 9607 4845

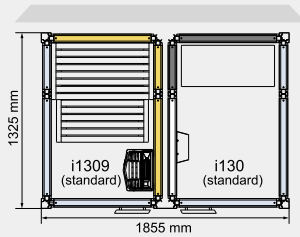

**TWIN 130/1309/W**  
White Art. no. 9607 4852  
Black Art. no. 9607 4853

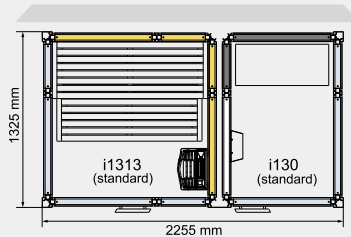

**TWIN 130/1313/W**  
White Art. no. 9607 4854  
Black Art. no. 9607 4855

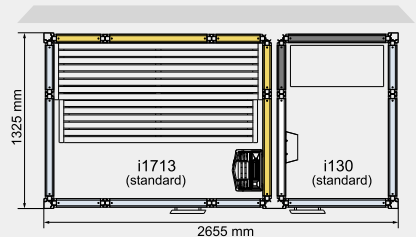

**TWIN 130/1713/W**  
White Art. no. 9607 4856  
Black Art. no. 9607 4857

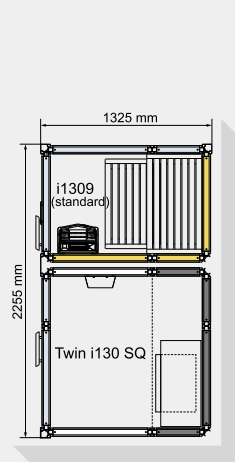

**TWIN 130 SQ /1309**  
White Art. no. 9607 4846  
Black Art. no. 9607 4847

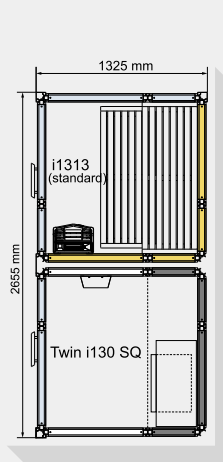

**TWIN 130 SQ /1313**  
White Art. no. 9607 4848  
Black Art. no. 9607 4849

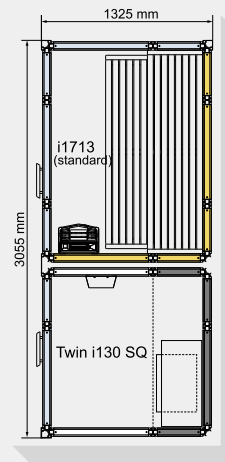

**TWIN 130 SQ /1713**  
White Art. no. 9607 4850  
Black Art. no. 9607 4851



# Vision

Tylö's Vision saunas are designed to suit either a commercial setting or your home. All of Tylö's Vision models have an attractive exterior with large expanses of glass and wall panels made of the finest alder, all crowned with a projecting ceiling cornice containing inset downlights. The elegantly curved glass door can be hung both from the right and the left, increasing the potential to achieve a well-planned home spa.

The door sits in a robust alder frame, and like the other glazed surfaces it is made of tempered safety glass. The handle has a magnetic door catch.



Find out more at  
[www.tylo.com](http://www.tylo.com)

Quite simply a piece of craftsmanship

Inset downlights in the projecting ceiling cornice spread a pleasant glow over the outside of the walls, which are made of alder. The walls and ceiling on the inside, made of natural aspen, contrast wonderfully with the fittings made of narrow strips of alder.

The wide, comfortable benches are fitted with skirting panels, and behind the beautifully designed backrest, indirect lighting contributes to the warm and welcoming impression.



The sturdy door, like the other glazed surfaces, is made of tinted, tempered safety glass. The door leaf sits in a robust alder frame and has a handle with a magnetic door catch. And you can, of course, decide whether you want the door to be hung on the right or left-hand side.

Tylö's Vision sauna is available in seven different models, all of which can be reversed – see the layouts below where you will also find information about the optimum heater output required for the various sauna sizes.

### Included:

- Thermally-insulated wall and ceiling sections clad in wooden panels
- Interior fittings made of narrow strips of alder
- DGR glass door
- Light fittings and transformer
- Heater installation plate
- Detailing for concealed wiring
- Aluminium floor frame
- Corner and ceiling mouldings
- Vents
- Assembly hardware

### Layouts Vision

All these saunas can also be installed reversed.  
External roof height 2030 mm.

Space Vision 150, corner entrance  
Art. no. 9510 7310

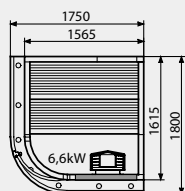

Space Vision 200, front entrance  
Art. no. 9510 7315

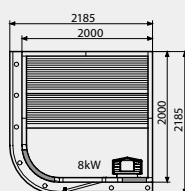

Space Vision 250, front entrance  
Art. no. 9510 7320

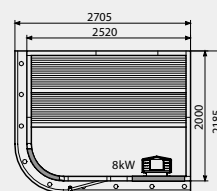

Midi Vision  
Art. no. 9510 7325

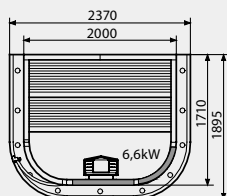

Round Vision 150  
Art. no. 9510 730

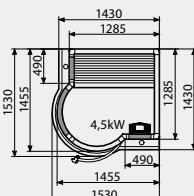

Round Vision 200  
Art. no. 9510 7305

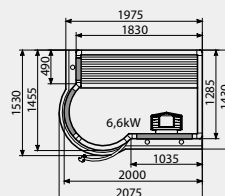

# Design rooms

Tylö's Design Line is a series of brand new sauna designs. Each one is an absolute concept of style, ready to be used. The next eight pages show the best we have to offer in terms of materials and design. You can combine features as you like or perhaps you prefer them as they are.

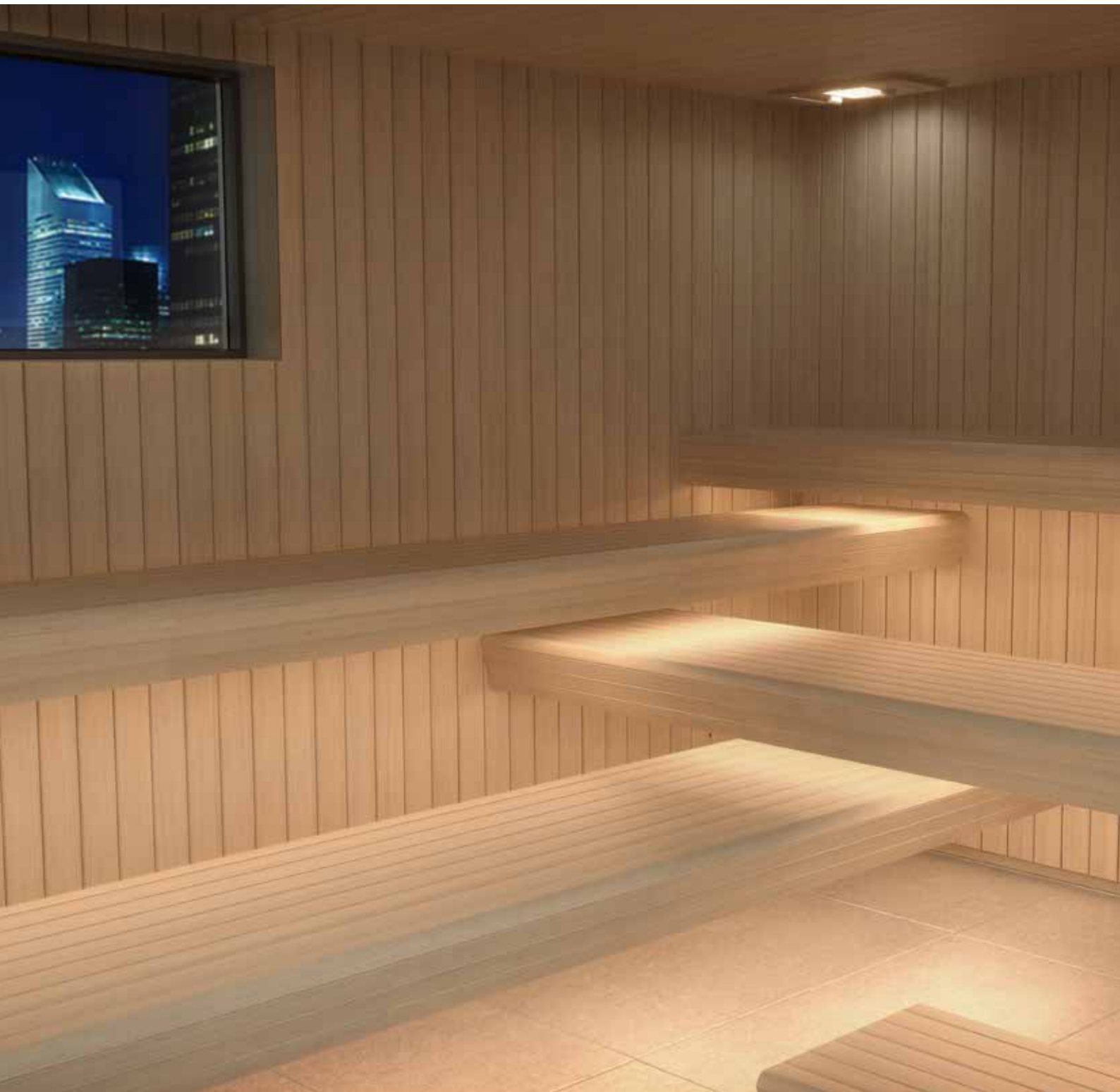



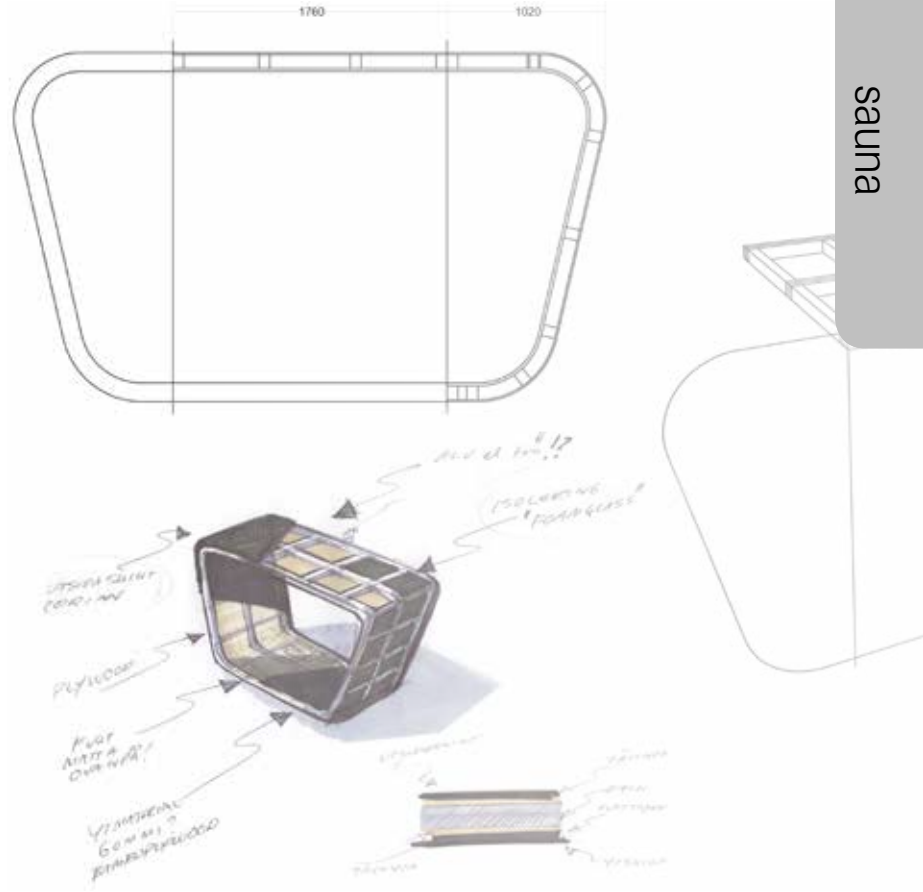

#### Four shades of luxury

New materials and designs catch the eye and Tylö is definitely not afraid of challenging conventional solutions. Passion, Sensation, Panorama and Simplicity turn preconceived notions on their heads, of what a sauna is or what a shower should look like. But don't be swayed by them - other designs, materials and features are just as possible.

#### Innovative design

Our product developers keep a close eye on developments in design, décor and architecture. When faced with a new challenge, they incorporate these trends with their knowledge of technology, electronics and different materials. Finally, they utilise our accumulated expertise of saunas, showers and steam baths. The results are usually astounding.





## Panorama



Find out more at  
[www.tylo.com](http://www.tylo.com)





Chic and beautifully designed, Panorama looks as though it belongs in a large, luxurious home. The combination of materials and the original style enhance the splendour and create a continuous flow of new angles and perspectives.

The discreet soffit light bar illuminates down onto large, tinted panes of glass and horizontal tiger ash. The interior is clad in vertical aspen panels. The three or four levels of elegantly overlapping benches are also made of aspen.





# Sensation

Find out more at [www.tylo.com](http://www.tylo.com)



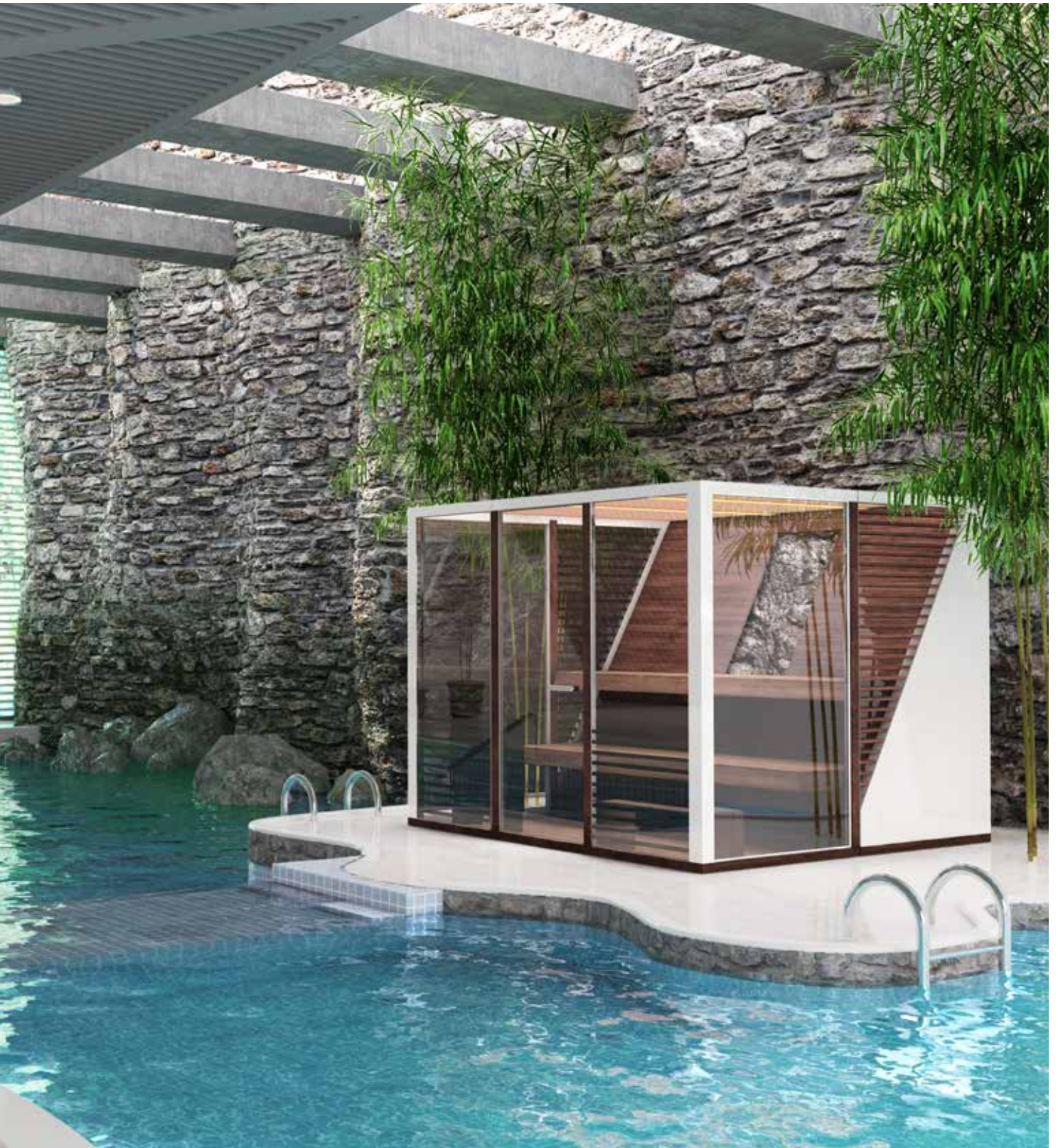

There is good reason why the waterfall is centrally positioned. The dark wood and beautiful design with diagonal ribs are magnificent, but all eyes are on the steaming, cascading water feature. Even without this option, you can expect a superb sauna experience.

The sloping rear wall saves energy and creates a gentle thermal breeze inside the room. The emphasis on natural materials inside the sauna is highlighted by the heat-treated espresso aspen on the rear wall, interior lining and other features. The benches are made of slightly lighter tiger ash and the exterior cladding has a high-gloss finish.





## Simplicity



Find out more at  
[www.tylo.com](http://www.tylo.com)

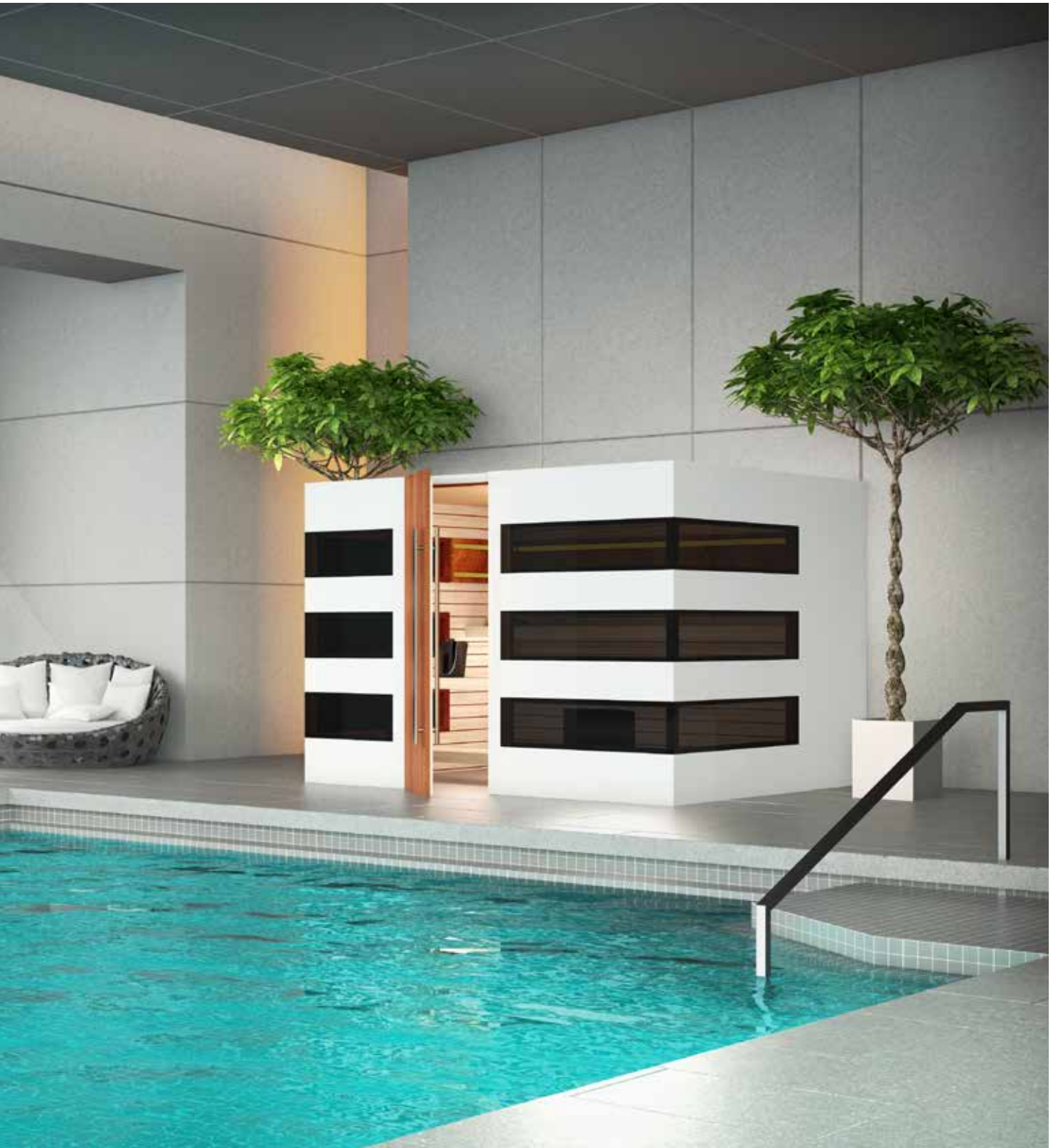

By combining the best of design and material development, Simplicity challenges the way a sauna can and should look. The unexpected lines greatly enhance the feeling of freshness and exclusiveness.

This stripped-down, cube-like sauna has a high-gloss lacquered exterior with seamlessly integrated lateral windows. The door is made of stylish tiger ash. The beautiful caulked aspen benches create a staircase look inside the sauna and the atmospheric lighting further heightens the feeling of novelty and innovation.





## Passion



Find out more at  
[www.tylo.com](http://www.tylo.com)

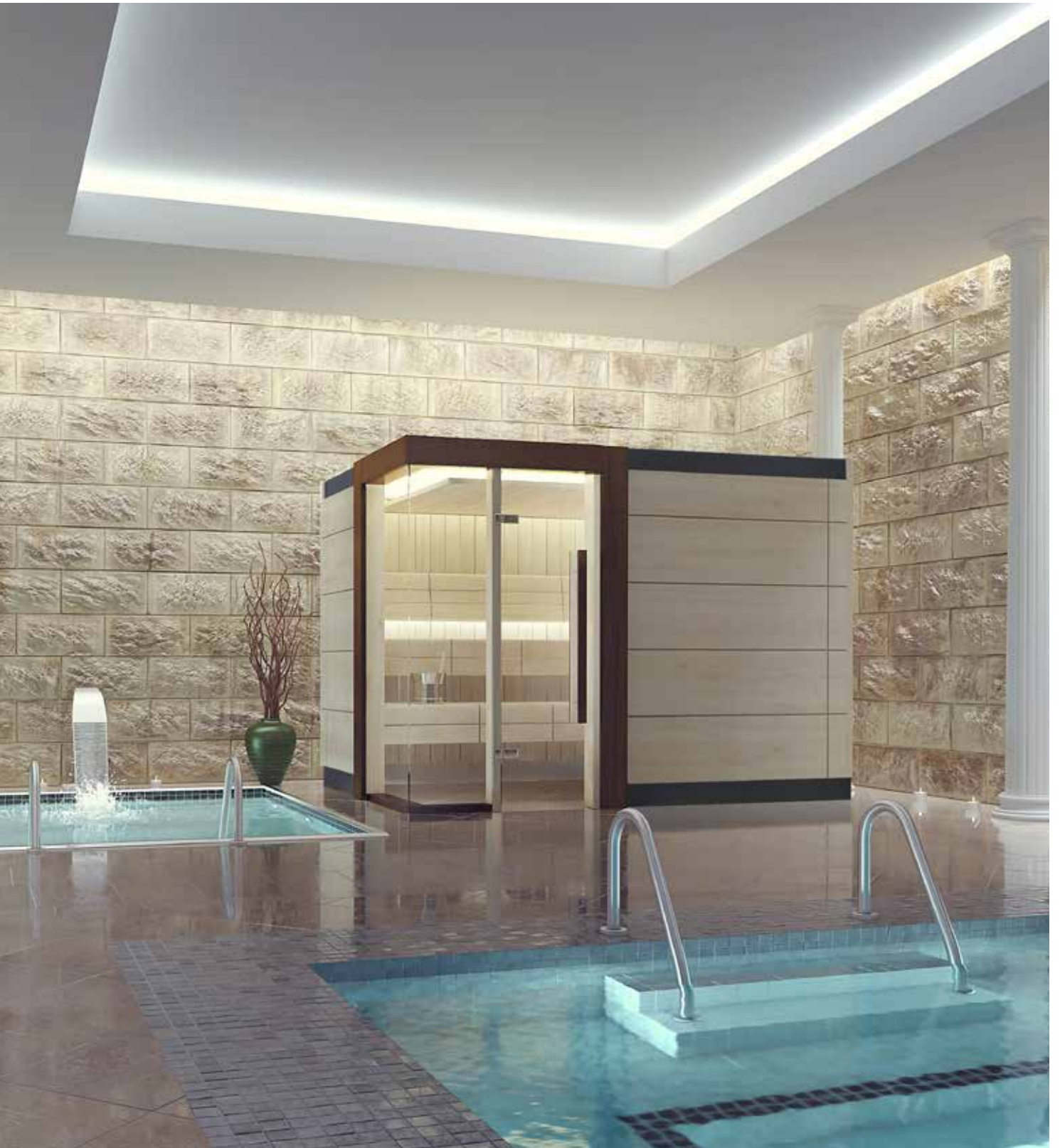

Passion takes Scandinavian style to its extreme. The light beech veneer on the outside sets the tone and is complemented inside by aspen panels and American alder and aspen benches.

Passion features a double ceiling with a light bar in the lower part, subtly illuminating the upper ceiling from below. Next to the heater is a beautiful slate wall and the door frame is made of espresso ash wood. The pattern of glass and wood on the front provides just the right amount of seclusion.



# A myriad of options

Tylö lets you create a haven in your home, tailored to your wishes. Complementing the Scandinavian design and smart solutions are a multitude of options, which include different types of wood, made-to-measure benches and lighting that creates a restful and luxurious mood. We recommend our glazed sections if you have a beautiful view to admire or want to add to the feeling of space.

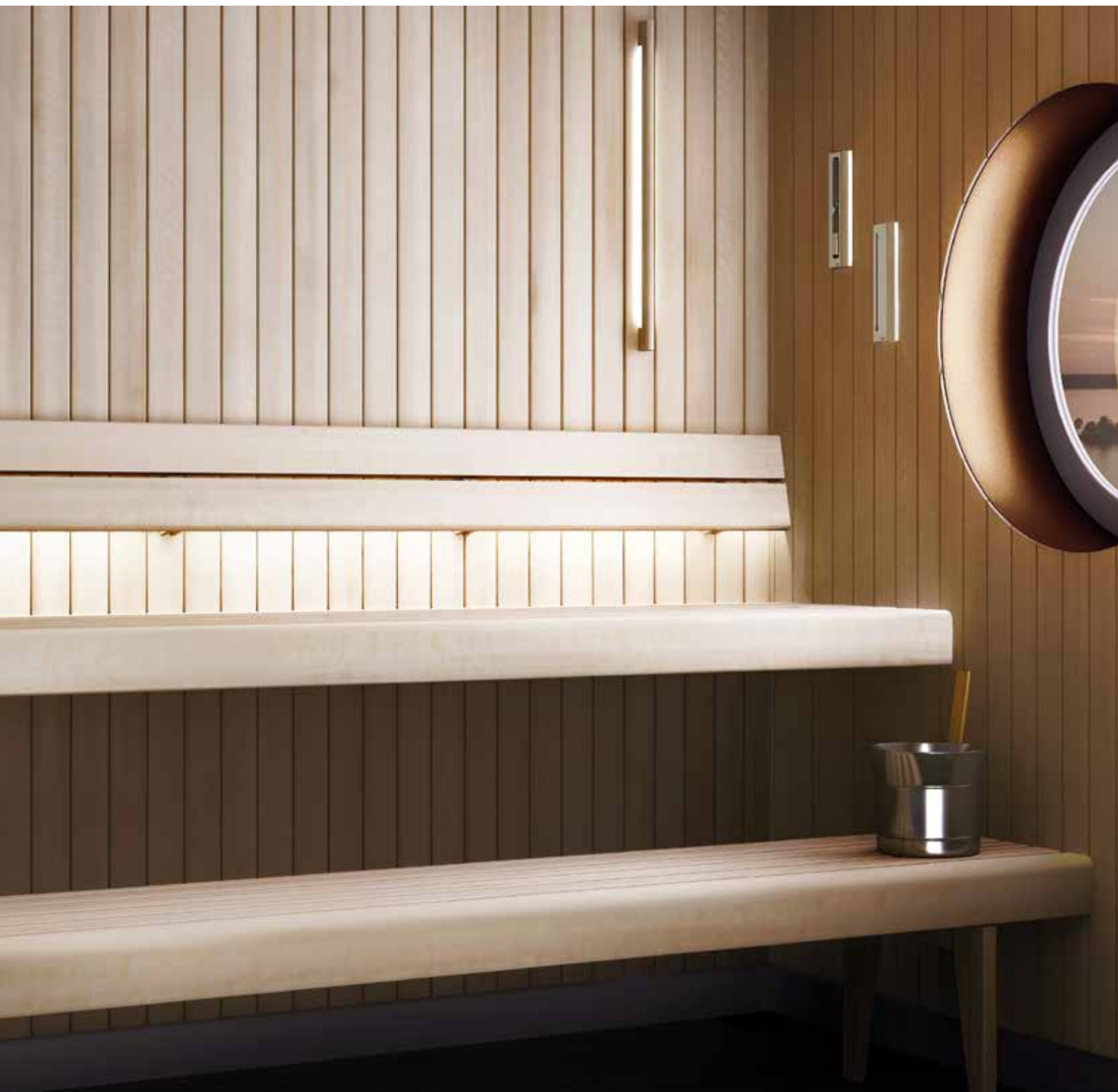



Find out more at  
[www.tylo.com](http://www.tylo.com)



### Different species of wood

Whether you're building afresh or renovating your sauna, Tylo has a number of high-quality and exclusive species of wood, each with its own special look and feel, for your sauna. We offer a choice of traditional spruce, fragrant cedar and two types of aspen.



Panel STS 240 aspen/TH  
 Heat-treated aspen



Panel STS 240 cedar  
 Cedar



Panel STS 240 aspen  
 Aspen



Panel STS 240 spruce  
 Spruce



The right interior enhances  
the overall feel

Find out more at  
[www.tylo.com](http://www.tylo.com)



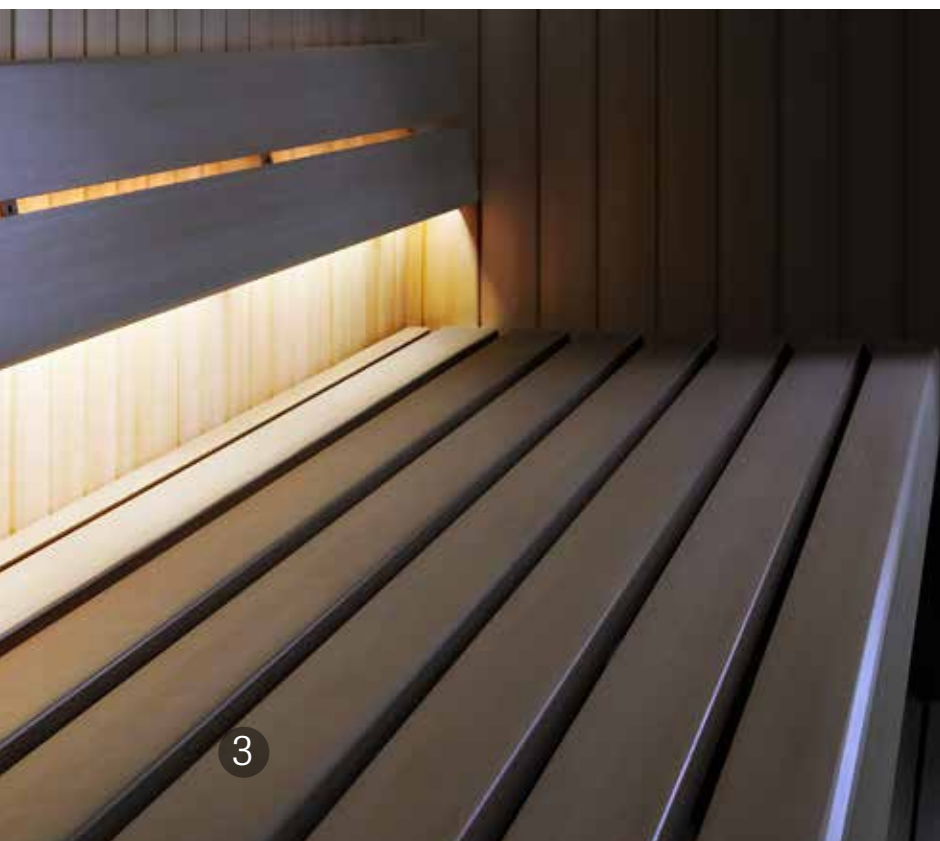

Backrests	Size	Art. no.
Aspes	mm	
Backrest E28	190 x 905	9039 5000
Backrest E28	190 x 1160	9039 5008
Backrest E28	190 x 1415	9039 5010
Backrest E28	190 x 1670	9039 5012
Backrest E28	190 x 1925	9039 5014
Backrest E28	190 x 2180	9039 5016
Backrest E28	190 x 2435	9039 5018

Benches*	Size	Art. no.
Aspen	mm	
Bench E28	410 x 610	9023 4100
Bench E28	410 x 865	9023 4102
Bench E28	410 x 925	9023 4103
Bench E28	410 x 1015	9023 4104
Bench E28	410 x 1180	9023 4106
Bench E28	410 x 1270	9023 4108
Bench E28	410 x 1435	9023 4109
Bench E28	410 x 1525	9023 4110
Bench E28	410 x 1780	9023 4112
Bench E28	410 x 2035	9023 4114
Bench E28	600 x 1180	9023 4206
Bench E28	600 x 1435	9023 4209
Bench E28	600 x 1525	9023 4210
Bench E28	600 x 1780	9023 4212
Bench E28	600 x 2035	9023 4214
Bench E28	600 x 2290	9023 4216
Bench E28	600 x 2545	9023 4218
Bench E68	410 x 610	9023 4300
Bench E68	410 x 865	9023 4302
Bench E68	410 x 925	9023 4303
Bench E68	410 x 1015	9023 4304
Bench E68	410 x 1180	9023 4305
Bench E68	410 x 1270	9023 4306
Bench E68	410 x 1435	9023 4307
Bench E68	410 x 1525	9023 4308
Bench E68	410 x 1780	9023 4310
Bench E68	410 x 2035	9023 4312
Bench E68	600 x 1180	9023 4314
Bench E68	600 x 1435	9023 4315
Bench E68	600 x 1525	9023 4316
Bench E68	600 x 1780	9023 4318
Bench E68	600 x 2035	9023 4320
Bench E68	600 x 2290	9023 4322
Bench E68	600 x 2545	9023 4324

When it comes to the interior space of your sauna, you might find prefabricated modules a smart choice. As well as saving time and effort, you can be sure of really stunning results. Choose from wide-slat benches made of aspen, or narrow-slat benches made of alder or aspen. The features create a feeling of traditional craftsmanship, while the design is a more contemporary, Scandinavian style. Installation is simple and your sauna will look fabulous whichever wood and style you choose.

**1.** E28 benches. **2.** Aspen backrest. **3.** E68 benches.

\*The benches can be cut 10 cm on each side. Tylö recommends the deep bench if space allows.





### 1. Skirting panels

Prefabricated skirting panels screen off the gaps between the benches. Made of the finest aspen and alder. Can be cut to the correct length. This illustration shows aspen skirting panels.

Skirting panels	Size mm	Art. no. narrow strips	Skirting panels	Size mm	Art. no. narrow strips
Alder			Aspen		
Screen 75	755 x 320	9039 4100	Screen 75	755 x 320	9039 4300
Screen 107	1070 x 320	9039 4105	Screen 107	1070 x 320	9039 4305
Screen 127	1275 x 320	9039 4110	Screen 127	1275 x 320	9039 4310
Screen 142	1420 x 320	9039 4115	Screen 142	1420 x 320	9039 4315
Screen 171	1710 x 320	9039 4120	Screen 171	1710 x 320	9039 4320
Screen 181	1810 x 320	9039 4125	Screen 181	1810 x 320	9039 4325
Screen 185	1850 x 320	9039 4130	Screen 185	1850 x 320	9039 4330
Screen 237	2370 x 320	9039 4135	Screen 237	2370 x 320	9039 4335
Screen 280	2800 x 320	9039 4140	Screen 280	2800 x 320	9039 4340

### 2. Sauna benches

Prefabricated sauna benches made of solid aspen and alder. The benches have a stable design with solidly glued dowels, with no visible screws. Can be cut to the correct length. This illustration shows aspen benches.

Benches	Size mm	Art. no. narrow strips	Benches	Size mm	Art. no. narrow strips
Alder			Aspen		
Bench 75	755 x 480	9023 1300	Bench 75	755 x 480	9023 1400
Bench 107 S	1070 x 397	9023 1302	Bench 107 S	1070 x 397	9023 1402
Bench 107	1070 x 480	9023 1303	Bench 107	1070 x 480	9023 1403
Bench 127	1275 x 480	9023 1305	Bench 127	1275 x 480	9023 1405
Bench 142 S	1420 x 397	9023 1307	Bench 142 S	1420 x 397	9023 1407
Bench 142	1420 x 480	9023 1308	Bench 142	1420 x 480	9023 1408
Bench 171	1710 x 480	9023 1310	Bench 171	1710 x 480	9023 1410
Bench 181	1810 x 565	9023 1312	Bench 181	1810 x 565	9023 1412
Bench 185 S	1850 x 480	9023 1314	Bench 185 S	1850 x 480	9023 1414
Bench 185	1850 x 565	9023 1315	Bench 185	1850 x 565	9023 1415
Bench 237	2370 x 565	9023 1320	Bench 237	2370 x 565	9023 1420
Bench 280	2800 x 565	9023 1325	Bench 280	2800 x 565	9023 1425



### 3. Backrests

The prefabricated backrests made of aspen and alder are comfortably contoured and also serve to screen off light fittings, creating a gentle, indirect glow in the sauna. Can be cut to the correct length. This illustration shows an alder backrest.

Backrests	Size mm	Art. no. narrow strips	Backrests	Size mm	Art. no. narrow strips
Alder			Aspen		
Backrests 99	990 x 270	9039 3100	Backrests 99	990 x 270	9039 3200
Backrests 119	1190 x 270	9039 3105	Backrests 119	1190 x 270	9039 3205
Backrests 138	1380 x 270	9039 3110	Backrests 138	1380 x 270	9039 3210
Backrests 174	1740 x 270	9039 3115	Backrests 174	1740 x 270	9039 3215
Backrests 214	2140 x 270	9039 3120	Backrests 214	2140 x 270	9039 3220
Backrests 226	2260 x 270	9039 3125	Backrests 226	2260 x 270	9039 3225
Backrests 269	2690 x 270	9039 3135	Backrests 269	2690 x 270	9039 3235

#### 4. Sauna panels

Tylö's sauna panels are available in four different designs, all made of grade A wood. The panels make a perfect match for Tylö's solid benches.

##### STS 240 spruce panel

Dimensions: 12 x 95 mm. Installation dimensions: 85 mm.

Pack of 10.

Art. no. 9490 1280

##### 240 cedar panel

Dimensions: 12 x 95 mm. Installation dimensions: 85 mm.

Pack of 10.

Art. no. 9490 0960

##### 240 aspen/TH panel

Heat-treated aspen panel (no knots). Dimensions: 12 x 95 mm. Installation dimensions: 85 mm.

Pack of 10.

Art. no. 9490 1025

##### STS 240 aspen panel

Knot-free aspen panel. Dimensions: 12 x 95 mm. Installation dimensions: 85 mm. Pack of 10.

Art. no. 9490 1380



All Tylö sauna panels have the STS profile and measure 12 x 95 x 2400 mm.

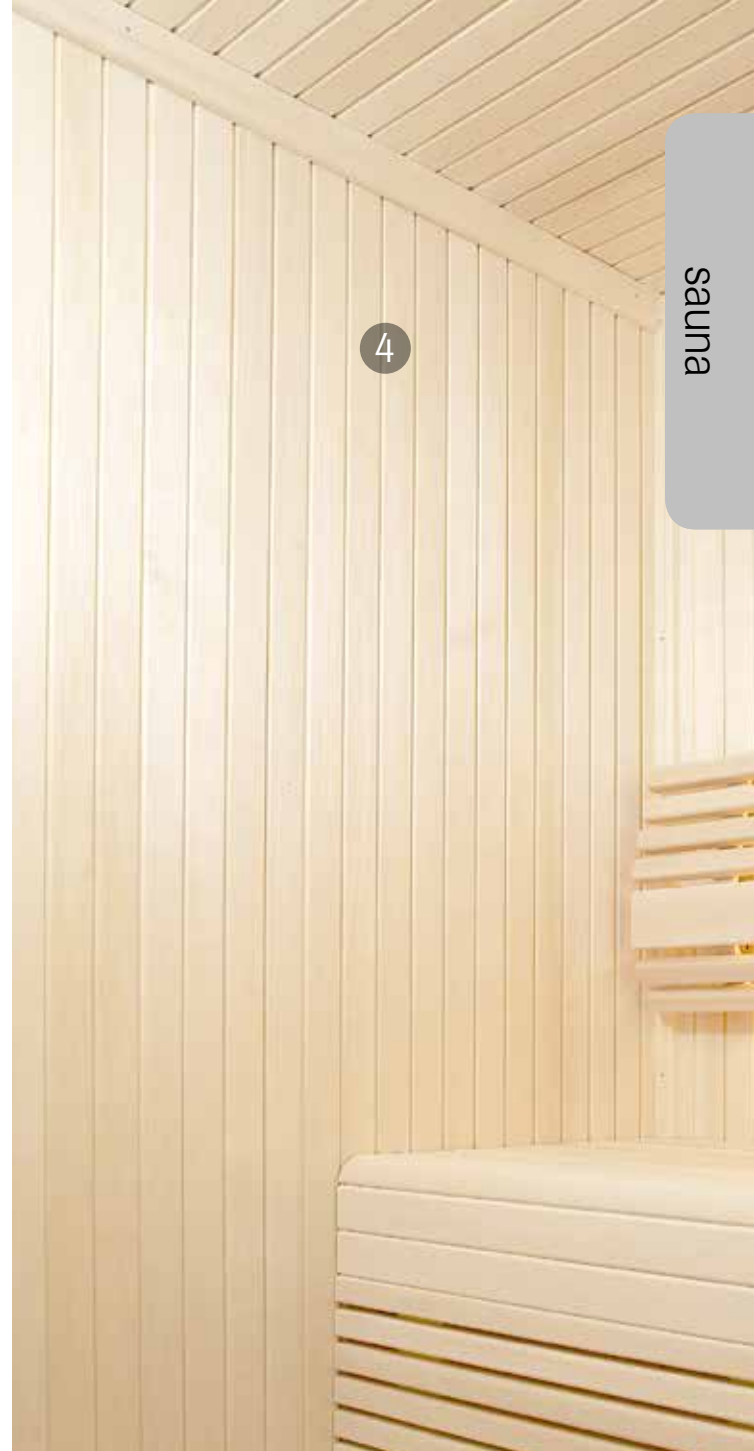

#### Armrest

For 480 mm bench. Prefabricated narrow-slat armrest that screens off and provides support when the end of the sauna bench does not reach the wall. Made of alder according to fixed dimensions.

Art. no. 9039 4202

#### Strip package

Contains three strips of light aspen, measuring 12 x 43 x 2400 mm. Suitable as a door lining, internal or external ceiling strip, etc.

Art. no. 9103 1575



# Sauna doors

Find out more at  
[www.tylo.com](http://www.tylo.com)



Every sauna door bearing Tylö's name is of the highest quality and is specially manufactured to withstand the considerable temperature differences between the outside and the inside of the sauna, without warping or becoming deformed. All doors are supplied with reliable magnetic door catches and can be hung to open either left or right.

If you want a sauna door with different dimensions or made from different materials, please request a quote.





### Sauna door DGL

Tylö's DGL sauna doors are a range of more exclusive sauna doors. DGL sauna doors have a door leaf made of tempered 8 mm safety glass, and are available in either tinted or clear glass. The solid aspen frame has a magnetic strip closing, while the actual door has sturdy hinges with a chromed appearance, concealed beneath a decorative, stainless steel housing. DGL 10x21 is also available for disabled access.

Tinted glass, 7 x 19 Art. no. 9103 1700	Clear glass, 7 x 21 Art. no. 9103 1745	Tinted glass, 8 x 21 Art. no. 9103 1750
Clear glass, 7 x 19 Art. no. 9103 1705	Tinted glass, 8 x 19 Art. no. 9103 1710	Clear glass, 8 x 21 Art. no. 9103 1755
Tinted glass, 7 x 20 Art. no. 9103 1720	Clear glass, 8 x 19 Art. no. 9103 1715	Tinted glass, 10 x 21 Art. no. 9103 1770
Clear glass, 7 x 20 Art. no. 9103 1725	Tinted glass, 8 x 20 Art. no. 9103 1730	Clear glass, 10 x 21 Art. no. 9103 1775
Tinted glass, 7 x 21 Art. no. 9103 1740	Clear glass, 8 x 20 Art. no. 9103 1735	



### Sauna door DGB

Tylö's DGB sauna doors are a range of simple yet robust sauna doors at a favourable price. DGB sauna doors have a door leaf made of tempered 8 mm safety glass, and are supplied in either tinted or clear glass. The finger-jointed standard frame (92 mm) is made of pine with a silicone sealing strip. The door handle is made of aspen, with magnetic lock closing.

Tinted glass, 7 x 19 Art. no. 9103 1500	Clear glass, 7 x 21 Art. no. 9103 1545	Tinted glass, 8 x 21 Art. no. 9103 1550
Clear glass, 7 x 19 Art. no. 9103 1505	Tinted glass, 8 x 19 Art. no. 9103 1510	Clear glass, 8 x 21 Art. no. 9103 1555
Tinted glass, 7 x 20 Art. no. 9103 1520	Clear glass, 8 x 19 Art. no. 9103 1515	
Clear glass, 7 x 20 Art. no. 9103 1525	Tinted glass, 8 x 20 Art. no. 9103 1530	
Tinted glass, 7 x 21 Art. no. 9103 1540	Clear glass, 8 x 20 Art. no. 9103 1535	





## DGM sauna door

Tinted, tempered safety glass door with spruce frame. Sturdy aluminium hinges concealed beneath a decorative, stainless steel housing. Supplied with silicone sealing strip. Specially designed for wheelchair access without a threshold (threshold available as an accessory) and with an extra wide opening. Fitted with a stainless steel door edge guard.

### DGM-63-190

Outer frame dimensions 1850 x 622 x 68 mm,  
width of opening 1738 x 510 mm.

Spruce, tinted glass  
Art. no. 9103 1060

Aspen, tinted glass  
Art. no. 9103 1050

### DGM-72-190

Outer frame dimensions 1850 x 710 x 68 mm,  
width of opening 1738 x 598 mm.

Spruce, tinted glass  
Art. no. 9103 1020

Aspen, tinted glass  
Art. no. 9103 1000

Alder, tinted glass  
Art. no. 9103 1010



### 1. DGP 190 Alder / Aspen

Exclusive sauna door made of 6 mm tinted, tempered safety glass. The elegant handle runs the entire height of the door, inside and out. Door closing with magnetic strip.

### 2. DGR 190 Alder

An extremely exclusive sauna

door. The door is made of curved 6 mm tinted, tempered safety glass. Longitudinal handles inside and out. Magnetic strip closing.

### 3. DWG/DWB

DWG is a classic model with a large window made of clear, tempered safety glass. Clad

inside and out with beautiful spruce or aspen panels. The DWB is the same model without glass.

### 4. Alu Line sauna door

The stylish glass door has an aluminium frame, elegant handle and magnetic sealing strip. The strips and handle

on the inside of the door are made of alder. The door can be fitted to open on the left or right hand side. Matches Tylö's 60 G steam door in the same design.

#### DGP 190 Alder/Aspen

Outer frame dimensions 1850 x 710 x 68 mm (1900 with 50 mm insertion), width of opening 1738 x 598 mm.

#### DGP 190 Alder

Art. no. 9103 2045

#### DGP 190 Aspen

Art. no. 9103 2050

#### DGR 190 Alder

Outer frame dimensions 1900 x 786 x 71 mm, width of opening 1788 x 618 mm.

#### DGR 190 Alder

Art. no. 9103 2035

#### DWG/DWB

Outer frame dimensions 1890 x 690 mm, width of opening 1850 x 595 mm

#### DWG 7x19 ASPEN

Art. no. 9511 3110

#### DWG 7x19 SPRUCE

Art. no. 9511 3115

#### DWB 7x19 ASPEN

Art. no. 9511 3120

#### DWB 7x19 SPRUCE

Art. no. 9511 3125

#### Alu Line sauna door

Outer frame dimensions 1870 x 778 mm. Tinted glass and aluminium profiles.

#### Alu Line sauna door

Art. no. 9103 2055



### Threshold

Wooden threshold for subsequent installation. Suitable for DGB and DGL doors with door widths 7 and 8. Available in spruce and aspen. Size: 30 x 92 mm.

Threshold DGB 7 spruce  
Art. no. 9103 1560

Threshold DGL 7 aspen  
Art. no. 9103 1561

Threshold DGB 8 spruce  
Art. no. 9103 1565

Threshold DGL 8 aspen  
Art. no. 9103 1566



### Shutting device, wood

For controlled closure of your wooden door. The perfect complement to the door-closer below.

Art. no. 9030 1000

### Shutting device for glass doors

For controlled closure of glass doors. Can be combined with a door-closer for best results

Art. no. 9030 1010



### Automatic door-closer

Fits on the hinge side of the door. Closes from a fully open position. For controlled closure, add the hydraulic shutting device described below.

Art. no. 9030 1030

## Glazed sections

By opening up the sauna with a glazed section, you let in more light, increase the space and enhance the sense of well-being. You have contact with the room outside and make your relaxation area a unified space. And as we make the glazed sections ourselves here at Tylö, they all satisfy the stringent safety and feature requirements.

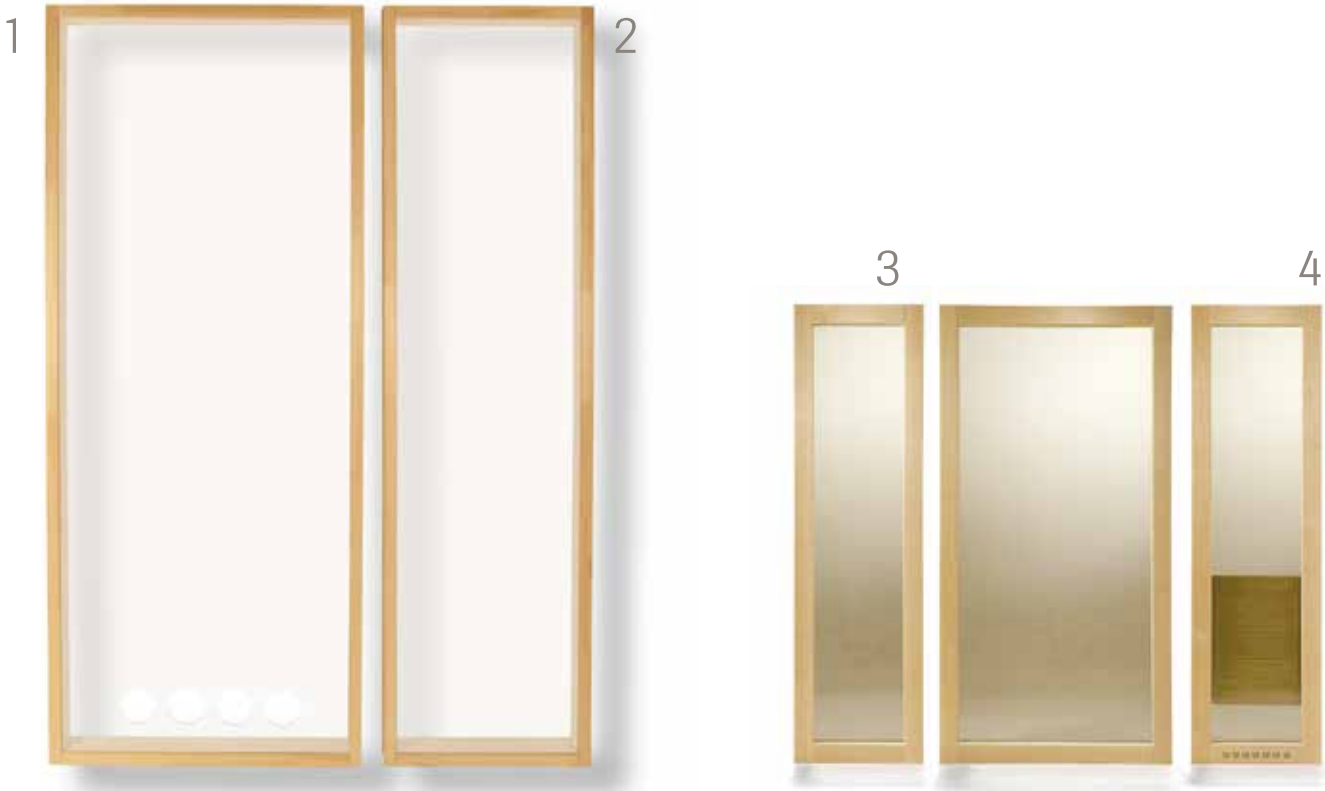

**1. Glazed section Evolve 9**  
Clear, tempered 8 mm safety glass in a sturdy wooden frame. Types H/v and L/v come with a wall mounting plate and have ventilation holes in the glass.

Dimensions:  
Type H= 1866x762x92 mm (hxwxd).  
Type L=1781x762x92 mm (hxwxd).

**2. Glazed section Evolve 6**  
Clear, tempered 8 mm safety glass in a sturdy wooden frame. Ventilation holes and mounting plate for fixing the heater to a wall.

Dimensions:  
Type H= 1866x506x92 mm (hxwxd).  
Type L=1781x506x92 mm (hxwxd).

**3. Glazed section 52**  
Prefabricated glazed sections made of 6 mm, tinted, tempered safety glass with solid frames of slightly darker alder.

Dimensions:  
1900 x 520 mm (hxw).

**4. Glazed section 52 VENT**  
Prefabricated glazed sections made of 6 mm, tinted, tempered safety glass with solid frames of slightly darker alder. Plus ventilation holes and mounting plate for fixing the heater to a wall.

Dimensions:  
1900 x 530 mm (hxw).

1. Glazed section Spruce 9L Art. no. 9511 3800	Glazed section Aspen 9L Art. no. 9511 3802	2. Glazed section Spruce 6L Art. no. 9511 3820	Glazed section Aspen 6L Art. no. 9511 3822	3. Glazed section 52 Alder Art. no. 9103 5040	4. Glazed section 52 Vent Alder Art. no. 9103 5030
Glazed section Spruce 9L/v Art. no. 9511 3805	Glazed section Aspen 9L/v Art. no. 9511 3807	Glazed section Spruce 6L/v Art. no. 9511 3825	Glazed section Aspen 6L/v Art. no. 9511 3827		Glazed section 95 Vent Alder Vision Art. no. 9103 5050
Glazed section Spruce 9H Art. no. 9511 3810	Glazed section Aspen 9H Art. no. 9511 3812	Glazed section Spruce 6H Art. no. 9511 3830	Glazed section Aspen 6H Art. no. 9511 3832		Glazed section 953 Alder Vision Art. no. 9103 5060
Glazed section Spruce 9H/v Art. no. 9511 3815	Glazed section Aspen 9H/v Art. no. 9511 3817	Glazed section Spruce 6H/v Art. no. 9511 3835	Glazed section Aspen 6H/v Art. no. 9511 3837		





# Sauna heaters

Close your eyes, and listen to your inner thoughts. Pour a ladle of water over the hot stones and listen to the hiss of the steam. The steam rises in a cloud that immerses you in pleasant heat; a liberating sensation. Our classic Tylö heater provides you with the pleasant experience of both a traditional sauna and a gentler steam sauna. Experience the sensation, feel revitalised and refreshed.





### **Thermosafe exterior covering**

The widely-acclaimed Thermosafe protective coating helps prevent burns on accidental contact. Overheat cut-outs, thermostats and temperature sensors are vital components that are selected with meticulous care to ensure maximum safety.



### **Ecosmart saunas**

Tylö's smart eco features have made the sauna experience far more energy efficient than before. Its patented "divided output" feature is good for your wallet, conscience and the environment. Once the temperature has reached the desired level, the heater switches to energy-saving mode.



### **Guaranteed safe**

Buying a prefabricated sauna room is not only the simplest and swiftest way to turn your dream of a sauna into reality, it's also the smartest and the safest too. That way you can be sure of a really well-made sauna that will serve you well, year after year after year.



# Sense

In a completely new design, Sense offers rapid and safe heat. The heater has a safety overheat cut-out, our patented, energy-saving "divided output" feature and standby mode for maximum energy efficiency. All heaters have a stainless steel stone compartment. Sense delivers reliable and precise heat every time you take a relaxing sauna. Choose either a wall-mounted or floor standing heater (legs are optional).



## 1. Sense Combi

Enjoy dry, wet and steam saunas with just one heater - the Sense Combi crossover heater. The elegant h2 control panel is also included.

## 2. Sense Plus + MPE

Sense Plus is designed for installation with a separate electronic control panel. Choice of EC 50, CC50 or h1.

A control panel is included with the Sense MPE.

## 3. Sense Sport + SK

Sense Sport is factory fitted with a time and temperature control knob mounted on the front side.

Sense SK is designed for installation with a separate electronic control panel. Choice of CC50\*, EC50\*, TS16, TS30 or h1\*.

Sense Combi 6 kW  
Art. no. 6100 1016

Sense Plus 6 kW  
Art. no. 6100 1017

Sense MPE 6 kW  
Art. no. 6100 1030

Sense Sport 6 kW  
Art. no. 6100 1018

Sense SK 6 kW  
Art. no. 6100 1025

Legs for Sense  
Art. no. 9000 1060

Sense Combi 8 kW  
Art. no. 6100 1010

Sense Plus 8 kW  
Art. no. 6100 1011

Sense MPE 8 kW  
Art. no. 6100 1032

Sense Sport 8 kW  
Art. no. 6100 1012

Sense SK 8 kW  
Art. no. 6100 1027

\*Requires RB box



### Sense – free your senses

Sense is a brand new line of sauna heaters, combining sleek design with the reliable functionality and genuine quality of Tylö. Sense's quick and pleasant heat, precise temperature control and smart Eco-functions will free all your senses. Not to mention that all the heaters are equipped with a fiber-coated outer shell in order to minimize the risk of burns, and an easy-to-clean, removable compartment for fragrant essences – all in a completely new design to complement any sauna.

### Full control - h1

All of Tylö's Combi heaters now come with a touch control panel and a bottle of essential oil (lavender 10 ml).



### Powerful stones

Tylö uses natural stones of igneous, black diabase rock that withstands rapid heating and cooling.

Option	Combi	Plus	MPE	Sport	SK
Stand	○	○	○	○	○
Fragrances	○	○	○	○	○
Steam feature	■	–	–	–	–
Control panel	■	○	■	Integral	○
5-year material guarantee	■	■	■	■	■

■ = included    ○ = option available    – = option not available



# Combi and Compact

Heaters for dry, steam or classic saunas. Separate electronic control panel for wall installation inside the sauna. The Combi heater adds a stylish look to your sauna with its aluminium top and stainless steel stone compartment. Equally sleek in design, the Compact has an integrated time and temperature control knob on its front and features a thermostat and mechanical timer.



## 1. Combi Compact 4

4 kW output, 400 V 2N~ (two-phase and neutral). For saunas of 1.2 to 4 cubic metres. Supplied with a 2.5 m cable.

Art. no. 6230 5000

## 2. Compact 2/4

A heater for small sauna rooms. Stone compartment for use with Mini sauna stones. With integral control panel at the base of the heater. 2.2–4.5 kW convertible for connection to 230 V (single-phase) or 400 V (two-phase with neutral). For sauna rooms measuring 1.5–4.5 m<sup>3</sup>.

Art. no. 6220 2000



Find out more at  
[www.tylo.com](http://www.tylo.com)



### Combi - as its name suggests

Combi is the heater that lets you enjoy dry, wet and steam saunas and has a built-in fragrance dispenser for aromatic essences.

### Guaranteed safe

Buying a prefabricated sauna room is not only the simplest and swiftest way to turn your dream of a sauna into reality; it's also the smartest and the safest too. That way you can be sure of a really well-made sauna that will serve you well, year after year after year.



### Electronic touch control panel

The Combi heater features a stylish control panel from the h-series. The control panel displays the time and temperature in the operating mode. You can set the temperature, control the humidity and set the start-up programme for the coming week with start repetition.

Option	Combi Compact 4	Compact
Stand	–	–
Fragrances	○	○
Steam feature	■	–
Control panel	■	Integral
5-year material guarantee	■	■

■ = included   ○ = option available   – = option not available

# Expression

Find out more at  
[www.tylo.com](http://www.tylo.com)



Expression takes sauna heaters to a new level. Expression's Scandinavian design and clean-cut lines raise the bar for how good a sauna heater can look. Tylö's latest heater has won the international Red Dot Design Award.



reddot design award

## Expression

A floor-standing heater with robust cast-iron legs and a reservoir for fragrance oil.  
Black. 10 kW output. 3 x 230 V, 3 x 400 V+N (requires RB30 + control panel at installation).

Art. no. 6100 1000

## Expression Combi

Same as Expression but with steam feature.  
Comes with a touch control panel from Tylö's h series. 10 kW output. 3 x 230 V, 3 x 400 V+N.

Art. no. 6100 1010





As well as stylish looks, Expression sports the same quality features as other Tylö heaters: twin side air chambers for enhanced warm air distribution, a fragrance dispenser and double-shell design. Expression also incorporates Tylö's energy-saving "divided output" feature. This means the heater automatically switches to energy-saving mode when the temperature reaches the desired level.



The Red Dot Design Award is an international distinction for outstanding design, conferred annually by Design Zentrum Nordrhein Westfalen. The award is sometimes also referred to as the "Nobel Prize for Designers".



Expression Combi also has a steam feature for a relaxing steam sauna. Water supply and drainage through mains connection.

Option	Expression	Expression Combi
Stand	■	■
Fragrances	–	■
Steam feature	–	■
Control panel and RB box	○	■
5-year material guarantee	■	■

■ = included    ○ = option available    – = option not available



# Sauna heaters for professional use



Find out more at  
[www.tylo.com](http://www.tylo.com)

For decades Tylo has been the obvious choice for saunas in hotels, clubs, swimming baths and sports facilities. Professionally managed environments like these prioritise reliability and low energy consumption, where frequent use subjects both designs and materials to punishing treatment.





### Tylö Megaline OC

The robust Megaline OC follows a proven tradition of excellence and can be installed in all kinds of saunas - even in the centre of your sauna if you so desire. Designed for saunas of 9 to 24 cubic metres. The slightly smaller Megaline OC 9 is suitable for saunas of 9 to 13 cubic metres. The elegant H2 control panel and the WE14 relay box control all the sauna features.



### Tylö Megaline SK

For saunas between 8 and 46 cubic metres. A steam generator can be connected to the SK heater to further enhance your sauna experience. Choose a traditional, deeply warming dry sauna or a soothing steam bath. The SK heater is an outstanding choice for public saunas, where expectations for a pleasurable sauna experience are high. Set-up is simple with the H2 control panel, which controls the sauna in conjunction with the WE14 relay box.



### SDK 10

Intended to be combined with separate control panel type TS 16, TS 30 or CC and relay box RB 30. 10.7 kW output. For sauna rooms measuring 10-18 m<sup>3</sup>. Width 650mm, depth 395mm, height 570mm.

### SD 16

Intended to be combined with separate control panel type TS 30 or CC and relay box RB 30. 16 kW output. For sauna rooms measuring 15-35 m<sup>3</sup>. **IMPORTANT!** 7-core cable between control panel/relay box and heater.

### SD 20

Combined with separate CC panel with relay box RB 60. 20 kW output. For sauna rooms measuring 22-43 m<sup>3</sup>. **IMPORTANT!** 7-core cable between control panel/relay box and heater.

SDK 10,7 kW  
Art. no. 6430 1009

SD 16 kW 3x400V  
Art. no. 6430 3000

SD 20 kW 3x400V  
Art. no. 6430 4000

**Designer's  
choice**



## Control panel h1

Electronic control panel, equipped with touch-control that not only displays the temperature and running time, but can also be programmed to start up to 24 hours in advance and run for between 0 and 23 hours.

The control panel allows you to regulate lighting in the sauna, set the maximum temperature, switch between Fahrenheit and Celsius, use a 12-hour or 24-hour format, set different languages, and more advanced settings and test options. Tylö h1 control panel can replace Tylö's CC10 and CC50 models. Size: 140 x 80 mm, depth 19 mm. Use with our RB relay box when installing our SDK/SD sauna heater.

Art. no. 7200 1020



Find out more at  
[www.tylo.com](http://www.tylo.com)

## Functions

With Tylö's h1 control panel, adjusting your sauna or steam bath can be performed simply and attractively.

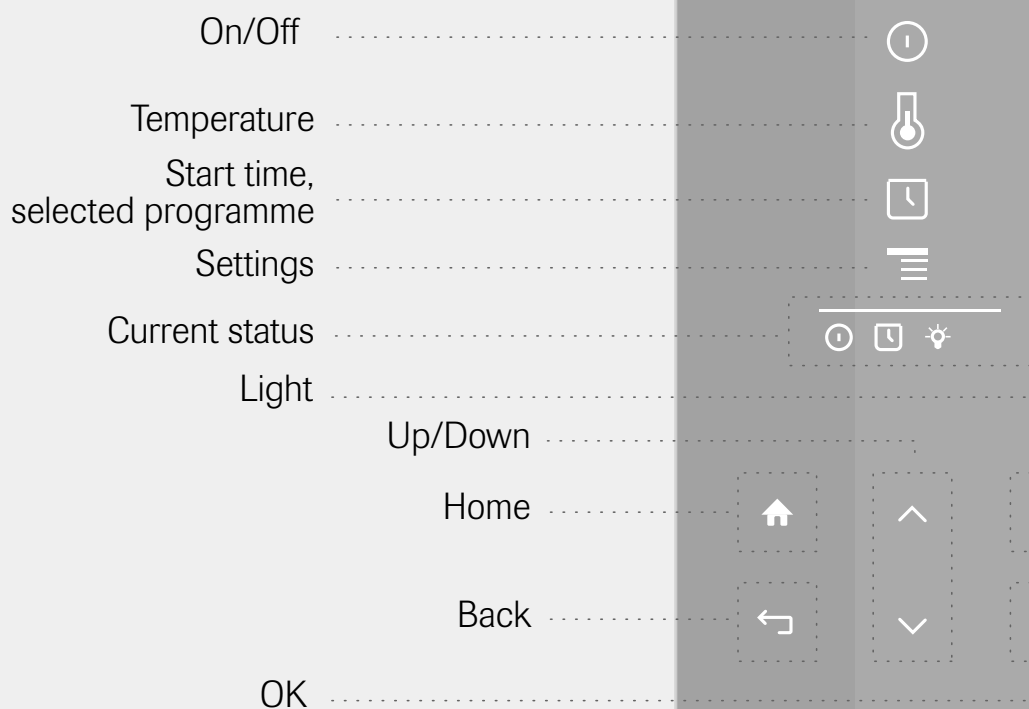



### EC 50

Tylö's EC50 control panel makes it simple and economical to have complete control of your sauna and steam bath. It has an easy-to-read display for convenient control of the start-up time, temperature and lighting. The panel incorporates a child-proof lock code to prevent accidental operation.

Compatible with the following heaters and steam generators: Sense Plus, SD, SDK, VB and VA. Size: 130 x 190 mm, depth 27 mm. IP 24.

Art. no. 7121 4050



### CC 300

The CC 300 is switchable to run between 1 and 24 hours and has a display that indicates temperature, remaining operating time, day and time. In addition the CC 300 is equipped with a switch for lighting, English instructions, a memory, security code and energy-saving stand-by function. The control panel can also be controlled from external units. Size: 130 x 190 mm, depth 27 mm. IP 24.

Art. no. 7111 5150

### External switch

On/off switch to control sauna from locations other than where the CC control panel is installed.

Art. no. 9090 8040



# Wood-fired

There's something special about a wood-fired sauna, and as we know how to appreciate sauna bathing in all its forms here at Tylö, we have a wide range of wood-fired sauna stoves for you to choose from as well. We are pleased to offer wood-fired stoves from the Finnish manufacturer, Kastor, renowned for its world-class quality.

The wood-fired stoves can be installed with Tylö's complete chimney systems made of easy-to-assemble modular components.



Find out more at  
[www.tylo.com](http://www.tylo.com)





## Karhu

From a purely aesthetic perspective, it's easy to see that Karhu's gleaming steel design can enhance any sauna interior. Yet it's the inside that really shines. Designed to be safe and strong, Karhu has a deep stone compartment, hot-air deflector and reinforced door. The smart Coanda air circulation system ensures optimal heating efficiency and reduced wood consumption. Combining minimalistic style with practical functionality, this model is designed to provide the ultimate in sauna comfort in every way.

Karhu 12 (12 kW, 5 – 12 m<sup>3</sup>)  
Art. no. 6405 4210

Karhu 20 (20 kW, 8 – 20 m<sup>3</sup>)  
Art. no. 6405 4220

Karhu 27 (27 kW, 17 – 27 m<sup>3</sup>)  
Art. no. 6405 4230

Karhu 37 (37 kW, 25 – 37 m<sup>3</sup>)  
Art. no. 6405 4240



## Karhu V/VV

The same as Karhu except with the water tank on the right or left-hand side (viewed from the front).

Karhu 12 V (12 kW, 5 – 10 m<sup>3</sup>)  
Art. no. 6405 4211

Karhu 20 V (18 kW, 8 – 17 m<sup>3</sup>)  
Art. no. 6405 4221

Karhu 27 V (20 kW, 17 – 24 m<sup>3</sup>)  
Art. no. 6405 4231

Karhu 37 V\* (30 kW, 25 – 34 m<sup>3</sup>)  
Art. no. 6405 4241

Karhu 12 VV\* (12 kW, 5 – 10 m<sup>3</sup>)  
Art. no. 6405 4212

Karhu 20 VV\* (18 kW, 8 – 17 m<sup>3</sup>)  
Art. no. 6405 4222

Karhu 27 VV\* (20 kW, 17 – 24 m<sup>3</sup>)  
Art. no. 6405 4232

Karhu 37 VV\* (30 kW, 25 – 34 m<sup>3</sup>)  
Art. no. 6405 4242



## Saga

Saga takes the pleasure of wood-fired saunas to new heights. Saga is available with 150 to 230 kg exposed stone and emits wonderfully soothing heat and steam. The stones with their rough surfaces make the stove a delightful focal point.

Saga 20 (18 kW, 8 – 20 m<sup>3</sup>)  
Art. no. 6405 4250



Following the merger of the two leading companies, Tylö and Helo, the TyloHelo World Group is the world's largest company in the sauna and steam bath sector, supplying the strongest brands on the market:

Tylö, Helo, Kastor, Finnleo and Amerrec. Our combined product portfolio contains everything from electric heaters, wood-fired sauna stoves, sauna rooms, steam rooms and infrared heat cabins. Coordination of development, production and marketing is beneficial to us and our customers.

## Tylö sauna heaters – technically speaking

Always choose the highest recommended output in relation to the volume of the sauna.

This is especially important in log saunas and saunas with glazed wall sections. The greater the heat output in relation to the size of the sauna room, the lower the overall energy consumption. Example: In a sauna measuring 4 m<sup>3</sup>, 6.6 kW is a better choice than 4.5 kW.

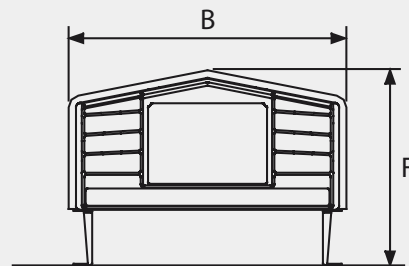
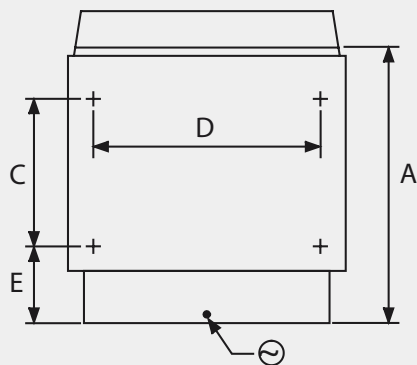

Install on the wall, with the bottom of the sauna heater 270 mm above the floor (170 mm for Compact and Combi 4).

## Sauna heater and control panels

Model	Output (kW)	Sauna volume (m <sup>3</sup> )	Minimum distance to side wall (mm)	Minimum ceiling height in the sauna (mm)	Suitable control panel	Weight without stones (kg)	Weight of stones (kg)	Size in mm, (see diagrams above)					
								A	B	C	D	E	F
Sense Combi 6	6.6	4 – 8	110	1900	h2 (included)	–	20	559	431	308	298	185	337
Sense Combi 8	8	6 – 12	110	1900	h2 (included)	–	20	559	431	308	298	185	337
Sense Plus 6	6.6	4 – 8	110	1900	CC50, EC50, h1	–	20	559	431	308	298	185	337
Sense Plus 8	8	6 – 12	110	1900	CC50, EC50, h1	–	20	559	431	308	298	185	337
Sense MPE 6	6,6	4 – 8	110	1900	Included	–	20	559	431	308	298	185	337
Sense MPE 8	8	6 – 12	110	1900	Included	–	20	559	431	308	298	185	337
Sense Sport 6	6.6	4 – 8	110	1900	Integral	–	20	559	431	308	298	185	337
Sense Sport 8	8	6 – 12	110	1900	Integral	–	20	559	431	308	298	185	337
Sense SK 6	6.6	4 – 8	110	1900	h1, EC50, CC50 + RB30, TS16*, TS30*	–	20	559	431	308	298	185	337
Sense SK 8	8	6 – 12	110	1900	h1, EC50, CC50 + RB30, TS16*, TS30*	–	20	559	431	308	298	185	337
Compact 2/4	2.2 – 4.5	1.2 – 4.5**	50	1900	Integral	6	7	400	310	195	260	135	170
Combi 4	4	1.2 – 4.5	50	1900	h1 (included)	12	7	400	310	375	245	225	225
Expression	10	10 – 18	200	1900	h1, CC50, CC300 +RB30	29	12	730	500	–	–	–	300
Expression Combi	10	10 – 18	200	1900	h2 + relay box (included)	32	12	730	500	–	–	–	300

\*The TS controls do not require a relay box (RB). \*\*Max 2.5 m<sup>3</sup> at 2.2 kW.

## Sauna heaters for professional use

Model	Output (kW)	Sauna volume (m <sup>3</sup> )	Minimum distance to side wall (mm)	Minimum ceiling height in the sauna (mm)	Suitable control panel	Weight without stones (kg)	Weight of stones (kg)	Size in mm (see diagrams to the left)					
								A	B	C	D	E	F
Expression	10	10 – 18	200	1900	h1, CC-50, CC-10, CC-300 + RB30	29	12	730	500	–	–	–	300
Tylö Megaline OC 9	9	8 – 13	25	1150	h2 + relay box WE 14	–	60	700	550	–	–	–	550
Tylö Megaline OC 10	10.5	9 – 15	25	1150		–	60	700	550	–	–	–	550
Tylö Megaline OC 12	12.0	10 – 18	65	1350		–	60	700	550	–	–	–	550
Tylö Megaline OC 15	15.0	14 – 24	65	1350		–	60	700	550	–	–	–	550
Tylö Megaline SK 18	18.0	18 – 30	140	2100		–	120	700	895	–	–	–	520
Tylö Megaline SK 21	21.0	24 – 36	140	2100		–	120	700	895	–	–	–	520
Tylö Megaline SK 26	26.0	30 – 46	140	2100		–	120	700	895	–	–	–	520
SDK 10	10.7	10 – 18	150	1900		TS 16, TS 30, CC + RB 30	30	25	570	650	310	600	165
SD 16	16	15 – 35	150	2100	TS 30, CC + RB 30	32	25	570	650	310	600	165	395
SD 20	20	22 – 43	150	2100	CC + RB 60	32	25	570	650	310	600	165	395

## Wood-fired sauna stoves

Model	Output (kW)	Sauna volume (m <sup>3</sup> )	Minimum distance to side wall (mm)			Flue opening diameter	Weight without stones (kg)	Weight of stones (kg)	Size in mm, width x depth x height
			Front	Side	Back				
Karhu-12	12	5 – 12	500	500	500	104	48	40	458 x 480 x 660
Karhu-12 V*/VV**	12	5 – 10	500	500	500	104	53	40	575 x 480 x 660
Karhu-20	18	8 – 20	500	500	500	104	62	60	485 x 480 x 780
Karhu-20 V*/VV**	18	8 – 17	500	500	500	104	67	60	650 x 480 x 780
Karhu-27	20	17 – 27	500	500	500	129	72	65	485 x 480 x 920
Karhu-27 V*/VV**	20	17 – 24	500	500	500	129	77	65	650 x 480 x 920
Karhu-37	30	25 – 37	500	500	500	129	118	75	570 x 580 x 920
Karhu-37 V*/VV**	30	25 – 34	500	500	500	129	125	75	730 x 580 x 920
Saga-20	18	8 – 20	500	250	500	104	82	150	600 x 580 x 820

\*Karhu V is the same as Karhu except with the water tank on the right-hand side (viewed from the front). \*\*Karhu VV is the same as Karhu except with the water tank on the left-hand side (viewed from the front).



# Accessories

It's all in the details. Our accessories are testimony to the truth in this little adage. A few carefully selected products from our range of accessories lend a personal touch to your sauna.





### Series of accessories

Sauna accessories are more than just extras. A few well-chosen products from our range of accessories will give your sauna a personal touch.



### New products

Our development centre is committed to continuously improving and creating new sauna and steam products. Over the years, many of these have become market leaders. Tylö's development work and manufacturing processes are closely monitored.



### Natural essential oils

Tylö's essential fragrance oils make your sauna experience all the more special and transport you into a world of absolute pleasure. Add a couple of drops of fragrant oil to a ladle of water and pour over the hot sauna stones to transform your sauna bath into an experience that stimulates all your senses.



## Your own sauna

– with that special touch

If you decide to build your own sauna, the money you save can be used to style your sauna the way you want it. The following pages show a selection of accessories that give your sauna a special finishing touch.



**1.** A few drops of Tylo's natural essential oils added to the sauna water will take you to new heights of relaxation. **2.** Fill a Tylo fragrance stone with water and an essential oil for a relaxing aroma sauna. **3.** Tylo's black diabase stones warm you instantly and produce wonderfully relaxing steam.



**4.** If you're looking to create a light, Scandinavian-style sauna, we recommend our Birch series of stainless steel and birch accessories. We offer a good basic range of accessories in a variety of styles to suit every taste. **5.** Anatomically designed, wooden headrests for relaxing moments in the sauna. Choose between fixed or adjustable models. **6.** Classically designed wooden bucket. **7.** Aluminium and dark wooden accessories in the Dark series.





### 1. Back scrubber

Back scrubber with peeling effect, designed to easily get to those hard-to-reach places on your back.  
Art. no. 9002 9042

### 2. Loofah

Loofah with peeling effect. Use in the sauna or shower.  
Art. no. 9002 9044

### 3. Adjustable sauna headrest

Comfortable design, height adjustable.  
42,5 x 37,5 x 7 cm.

Alder:  
Art. no. 9008 1012

Aspen:  
Art. no. 9008 1010

### 4. Accessories Tar and Classic

Two, classic-style, wooden buckets and a ladle. Holds 4 litres. Hemp handle.

### Tarred wooden bucket

Art. no. 9004 1052

### Tarred wooden ladle

Art. no. 9012 1017

### Classic ladle

Art. no. 9012 1025

### Classic bucket

Art. no. 9004 1010

### 5. Spa accessories

Bucket Spa  
Stainless steel bucket with bamboo handle. Capacity 12 litres.  
Art. no. 9004 1050

### Ladle Spa

Stainless steel ladle with bamboo handle.  
Art. nr. 9012 1050

### Hygro/Thermo Spa

Combination instrument complete with thermometer and hygrometer that can be mounted on the wall.  
Art. no. 9007 1050

### 6. Sauna kilts

Stylish anthracite grey kilts for men and women. 100% cotton. Made in Austria.

Men's kilt 60 x 153 cm  
Art. no. 9016 2092

Women's kilt 78 x 153 cm  
Art. no. 9016 2094

### 7. Fixed headrest

Wooden headrest with narrow slats. Fixed height. 37.5 x 27 x 8 cm.

Alder:  
Art. no. 9008 1016

Aspen:  
Art. no. 9008 1014

### 8. Textiles

Tylö's all-white textiles are an elegant collection that includes bath sheet, hand towel and kimono-inspired bathrobe.

#### Bath sheet

Bath sheet in highly absorbent 500 g white cotton. 70 x 150 cm.  
Art. no. 9016 1024

#### Hand towel

Hand towel in highly absorbent 500 g white cotton. 50 x 70 cm.  
Art. no. 9016 1026

#### Kimono

Elegant kimono with roomy sleeves in 330 g white cotton. The perfect garment to wrap up in after your sauna.  
S/M Art. no. 9016 1020  
L/XL Art. no. 9016 1022

### 9. Wooden headrest

Ergonomically designed headrest that moulds to your head.  
Art. no. 9008 1022

Backrest

Hemlock, 500 x 400 mm.

Art. no. 90081020





**1. Blonde accessories**

A series of accessories designed in aluminium with tasteful details in blonde wood.

**Bucket Blonde**  
Art. no. 9015 2000

**Ladle Blonde**  
Art. no. 9015 2010

**Thermometer Blonde**  
Art. no. 9015 2025

**Hygrometer Blonde**  
Art. no. 9015 2035

**Hygro/Thermo Blonde**  
Art. no. 9015 2045

**Hourglass Blonde**  
Art. no. 9015 2050

**Liquid thermometer Blonde**  
Art. no. 9015 2060

**Towel rack Blonde**  
Art. no. 9015 2070

**2. Dark accessories**

A series of accessories designed in aluminium with tasteful details in dark wood.

**Bucket Dark**  
Art. no. 9015 2700

**Ladle Dark**  
Art. no. 9015 2710

**Thermometer Dark**  
Art. no. 9015 2720

**Hygrometer Dark**  
Art. no. 9015 2730

**Hygro/Thermo Dark**  
Art. no. 9015 2740

**Hourglass Dark**  
Art. no. 9015 2750

**Liquid thermometer Dark**  
Art. no. 9015 2760

**Towel rack Dark**  
Art. no. 9015 2770

**3. Birch accessories**

A complete series of accessories with details in blonde birch and stainless steel.

**Bucket 4 litre 4l Birch**  
Art. no. 9015 2860

**Ladle 400 mm Birch**  
Art. no. 9015 2850

**Thermometer Birch**  
Art. no. 9015 2821

**Hygrometer Birch**  
Art. no. 9015 2831

**Hygro/Thermo Birch**  
Art. no. 9015 2811

**Hourglass Birch**  
Art. no. 9015 2840

**4. Gift pack Blonde**

Contains ladle, bucket, fragrance, hygro/thermo  
Art. no. 9015 2882

**5. Gift pack Dark**

Contains ladle, bucket, fragrance, hygro/thermo  
Art. no. 9015 2884

**6. Bucket 6 litre and Ladle Birch**

Art. no. 9015 2870

**7. Collage SC**

Art. no. 9007 1012





sauna



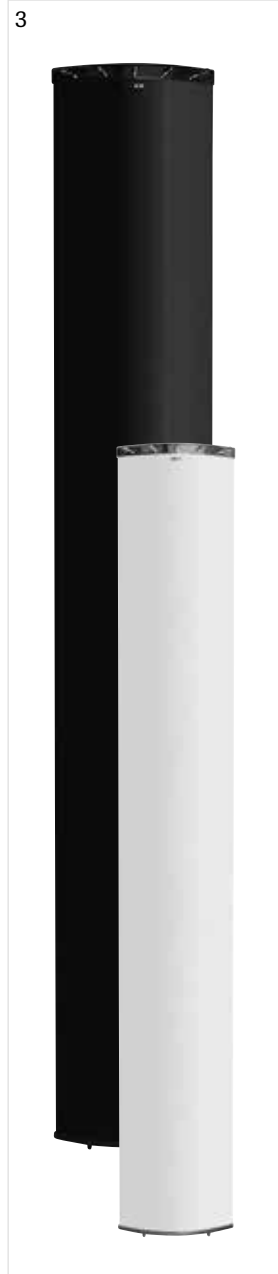

**1. Loudspeaker**

Steam and heat-resistant design. Suitable for recessed installation inside the sauna. 50 W output.

**Loudspeaker A**

Steam and heat-resistant design, suitable for recessed installation under the lower bench in the sauna. Installation size: Ø 117 mm, depth 60 mm. Supplied in pairs.

Art. no. 9080 2000

**Loudspeaker B**

For surface mounting. Size: 230 x 145, depth 165 mm. Supplied in pairs.

Art. no. 9080 3000

**2. Water sprinkler**

Innovative solution for sprinkling water. Connect to hot or cold water. Includes 7 m of twined hemp rope running through brass eyebolts, a sprinkler head, a valve box with lever

and rope bolt, and plumbing connections. Available in a gift package complete with bronze plaque.

Art. no. 9034 1000

**3. Towel rail**

With their exquisite design, our new towel rails are perfectly suited for the modern bathroom, just like other Tylö products. Five hangers on a small, slender surface, with the column painted white or black. Size: 1430 x 210 mm (hwxw). Distance from wall: 110 mm. Output: 140 W.

White

Art. no. 9080 1035

Black

Art. no. 9080 1040

**4. Sauna stones**

Natural stones of black diabase that tolerate rapid heating and cooling.

**Sauna stone**

One carton (approx. 14 kg) is sufficient for heaters with outputs of 6.6-8 kW. Heaters with outputs of 10.7-20 kW require two cartons.

Art. no. 9014 1000

**Mini compact sauna stones**

7 kg diabase stones.

Art. no. 9014 1005

**Mini Sense sauna stones**

20 kg diabase stones. One box is just enough for a Sense heater.

Art. no. 9014 1050

**Wood-fired sauna stones**

Larger stones of black diabase that tolerate water sprinkling; suitable for wood-fired sauna stoves. The larger stones provide better air circulation and retain heat longer. One carton weighs 20 kg.

Art. no. 9014 1007

**5. Shower barrel**

10 litre shower barrel with automatic water refill for a refreshing friction bath after your sauna.

Art. no. 9002 9050



**1. Collection of essential oils**  
A collection of five specially selected essential oils in a gift package.  
Art. no. 9002 3024

**2. Fragrance dispenser; Tylö Fresh**  
Fragrance dispenser for saunas, steam baths and wherever else Tylö's aromatic essences may be needed. Operates silently and automatically. Installation distance: max. 2 metres between fragrance dispenser and nozzle. Tip! Up to four fragrance dispensers can be connected to a single control panel to vary the fragrance in one or more rooms. Size: 350 x 200 mm.  
Art. no. 9090 8005

**CC Fresh**  
Electronic control panel for easy, automatic control of our Tylö Fresh dispenser. Supplied complete with transformer. Can be installed at any distance from the fragrance dispenser. Size: 130 x 190 mm, depth 27 mm.  
Art. no. 9090 8009

**Tylö Fresh Basic**  
Same as Tylö Fresh above, but with transformer and simple on/off function to manually control fragrance intensity. Can also be connected to lighting or similar functions. Intended for private use.  
Art. no. 9090 8007

**3. Essential oils**  
100% essential oils. A drop or two in a ladle of water will release an invigorating scent when sprinkled over the sauna stones.

**Eucalyptus 50 ml**  
Art. no. 9002 3022

**Eucalyptus 10 ml**  
Art. no. 9002 3010

**Peppermint 10 ml**  
Art. no. 9002 3012

**Lavender 10 ml**  
Art. no. 9002 3014

**Orange 10 ml**  
Art. no. 9002 3016

**Grapefruit 10 ml**  
Art. no. 9002 3018

**Lemon 10 ml**  
Art. no. 9002 3020

**Night time 10 ml**  
Art. no. 9002 3002

**Energy 10 ml**  
Art. no. 9002 3004

**Refresh 10 ml**  
Art. no. 9002 3006

**Harmony 10 ml**  
Art. no. 9002 3008

**Sensual 10 ml**  
Art. no. 9002 3000

**4. Concentrated fragrances**  
Dilute with water. For use with our earlier Tylö fragrance dispenser models, Sauna Fresh and Stream Fresh. 250 ml plastic bottle, also in packs of 24 and in 5 litre containers.

**Eucalyptus-250**  
Art. no. 9002 0000

**Eucalyptus-250/24**  
Art. no. 9002 0005

**Eucalyptus-5 lit**  
Art. no. 9002 2007

**Lemon-250**  
Art. no. 9002 0010

**Lemon-250/24**  
Art. no. 9002 0015

**Lemon-5 lit**  
Art. no. 9002 2012

**Pine-250**  
Art. no. 9002 0020

**Pine-250/24**  
Art. no. 9002 0025

**Pine-5 lit**  
Art. no. 9002 2017

**Peppermint-250**  
Art. no. 9002 0030

**Peppermint-250/24**  
Art. no. 9002 0035

**Peppermint-5 lit**  
Art. no. 9002 2022

**Menthol-250**  
Art. no. 9002 0040

**Menthol-250/24**  
Art. no. 9002 0045

**Menthol-5 lit**  
Art. no. 9002 2027

**5. Essential oils**  
Concentrate of natural fragrances specially produced for our Tylö Fresh fragrance dispenser for saunas and steam baths. 25 cl plastic bottle.

**Eucalyptus 25**  
Art. no. 9002 2030

**Peppermint 25**  
Art. no. 9002 2031

**Pine 25**  
Art. no. 9002 2032

**Lavender 25**  
Art. no. 9002 2033

**Citrus 25**  
Art. no. 9002 2036

**6. Fragrance stone**  
Place the fragrance stone on top of the stones in the sauna heater's stone compartment. Fill with water and essential oils for a relaxing aroma sauna.  
Art. no. 9002 9048

**7. Fragrance diffuser**  
Hang this fragrance diffuser over the sauna heater's bed of stones. Fill with water and essential oils for a relaxing aroma sauna.  
Art. no. 9002 9046





### 1. Sauna lighting LED

Lighting strip package incl. transformer. Can be installed both outside and inside the sauna (not in the ceiling). Warm-white glow. Voltage 12 V. IP 54.

Sauna lighting LED 1  
Length 500 mm. 2.4 Watt.  
Art. no. 9001 1022

Sauna lighting LED 2  
Length 870 mm. 4.1 Watt.  
Art. no. 9001 1024

Sauna lighting LED 3  
Length 2 st 500 mm. 4.4 Watt.  
Art. no. 9001 1026

Sauna lighting LED 4  
Length 3 st 500 mm. 7.2 Watt.  
Art. no. 9001 1028

### 2. Sauna lighting E28

Dimensions: 65 x 28 x 350/700/1070 mm. IP class 54. Warm-white glow. 12 V DC. Transformer not included.

Sauna lighting E28 1070 mm 4.1 W  
Art. no. 9001 1400

Sauna lighting E28 700 mm 2.4 W  
Art. no. 9001 1402

Sauna lighting E28 350 mm 0.8 W  
Art. no. 9001 1404

### 3. Sauna lighting E90

0.8 W. Dimensions: 90 x 90 x 200 mm. IP class 54. Warm-white glow. Transformer not included.  
Art. no. 9001 1420

### 4. Lighting strips

Install behind the backrest for pleasant, subdued lighting in the sauna. Can be cut to size. 12 V. Connect to our 12 V transformer. IP 65.

Lighting strip 38  
Length 38 cm. 12 W output.  
Art. no. 9001 1190

Lighting strip 50  
Length 50 cm. 15 W output.  
Art. no. 9001 1192

Lighting strip 90  
Length 90 cm. 27 W output.  
Art. no. 9001 1194

Lighting strip 190  
Length 190 cm. 57 W output.  
Art. no. 9001 1196

### 5. Sauna lamp 40 W

For wall mounting. White lamp holder E14. IP 55. Max 40 W. ø 90 mm, height 170 mm.  
Art. no. 9001 1000

### 6. Sauna lamp 60 W

As above, max 60 W. ø 205 mm, height 105 mm. IP 24.  
Art. no. 9001 1004

### 7. Transformer LED

200-240 V ~/12 V. Max. load 15 W. NB. The transformer must always be installed outside the sauna.  
Art. no. 9090 1030





**1. Lamp shade Aspen**  
Decorative aspen light shade, spreads a gentle glow in the sauna. Can be mounted on the wall. Fits our 40 W lamps.

Lamp shade Aspen-V  
Wall mounted. 50 x 28 x 15 cm.  
Art. no. 9009 1010

Lamp shade Aspen-H  
Corner mounted. 50 x 34 x 8 cm.  
Art. no. 9009 1011

**2. Lamp shade SR**  
Exclusive shade made of narrow aspen or alder slats. Fits lighting strip 38.

Lamp shade Aspen-V SR  
Wall mounted. 54 x 24 x 6 cm.  
Art. no. 9009 1017

Lamp shade Aspen-H SR  
Corner mounted. 54 x 22 x 4 cm.  
Art. no. 9009 1018

Lamp shade Alder-V SR  
Wall mounted. 54 x 24 x 6 cm.  
Art. no. 9009 1015

Lamp shade Alder-H SR  
Corner mounted. 54 x 22 x 4 cm.  
Art. no. 9009 1016

**3. Lamp shade 40/60**  
Wall-mounted pine shade for use with 40 W and 60 W sauna lamps. 25 x 25 x 14 cm.  
Art. no. 9009 1002

**4. Lamp shade GL**  
Elegant light shade made of specially chosen aspen. Fits our 40 W lamps. Intended for corner mounting. 50 x 36 x 4 cm.  
Art. no. 9009 1003

**5. Opus 100 H100**  
Sauna lamp. For wall mounting. Grey lamp holder G9, 25 W, 230 V, IP57, matt opalescent glass. ø 100 mm, height 100 mm.  
Art. no. 9001 1090

**6. Opus 100 H125**  
Sauna lamp. For wall/ceiling mounting. Grey lamp holder G9, 25 W, 230 V, IP57, matt opalescent glass. ø 100 mm, height 125 mm.  
Art. no. 9001 1091

**7. Opus 100 H175**  
Sauna lamp. For wall/ceiling mounting. Grey lamp holder E27, 40 W ceiling, 60 W wall, 230 V, IP57, matt opalescent glass. ø 100 mm, height 175 mm.  
Art. no. 9001 1092

**8. Opus 100 H175**  
Sauna lamp. For wall/ceiling mounting. Grey lamp holder E27, 40 W ceiling, 60 W wall, 230 V, IP57, clear glass. ø 100 mm, height 175 mm.  
Art. no. 9001 1093

**9. Opus 200 H135**  
Sauna lamp. For wall/ceiling mounting. Grey lamp holder E27, 40 W ceiling, 60 W wall, 230 V, IP57, matt opalescent glass. ø 200 mm, height 135 mm.  
Art. no. 9001 1094

**10. Light On Halogen**  
Sauna lamp. For wall/ceiling mounting. Grey GU10, 35 W, 230 V, IP 44. Diameter 100 mm, height 115 mm.  
Art. no. 9001 1003

**11. LED Downlight**  
LED downlight with long lifespan for ceiling mounting inside the sauna. Warm-white glow (3200-3500 K), 3 W output. Height 30 mm, ø 60 mm. The LED downlight is delivered in pairs in a carton together with a transformer. IP class 68.  
Art. no. 9001 1089

Transformer 12 V/210 W  
200-240 V~/12 V max. 210 W. Can be connected to a 7 m lighting strip or 42 x 5 W bulbs (Downlight).  
Art. no. 9090 1015

Transformer 12 V/60 W  
As above, but for max. 60 W.  
Art. no. 9090 1020



### 1. Ruben Sky LED

Spread a meditative, starlit mood in your sauna with our starry sky LED lighting. Choose between different colours for special occasions and to match the interior of the sauna.

Also included is a remote control that allows you to choose from seven pre-installed programmes or to install a personal programme up to 20 minutes in length, with as many as 20 colour changes.

Cable connections, 180mm mounting sleeves and electronic equipment are included. Can also be synchronised with lighting behind the backrest (through a slave).

Ruben Sky LED 20  
Qty 20 pcs. 11.6 W output.  
Art. no. 9001 1072

Ruben Sky LED 30  
Qty 30 pcs. 17.4 W output.  
Art. no. 9001 1074

Ruben Sky LED 40  
Qty 40 pcs. 23.2 W output.  
Art. no. 9001 1076

Ruben Sky LED 60  
Qty 60 pcs. 34.8 W output.  
Art. no. 9001 1078

### 2. Optical fibre lighting

Halogen lighting for mood-inducing lighting in all sorts of settings. The lighting source is embedded in a projector that is placed outside the sauna room. The length of the optical fibres determines the maximum distance between the projector and the light points.

Fiber Light Standard  
42 W with 6 light points (2 x 2 m, 2 x 2.5 m and 2 x 3 m).  
Art. no. 9001 1100

Fiber Light Public  
42 W with gilded light fittings and 8 light points (2 x 2.5 m, 3 x 3 m and 3 x 3.5 m).  
Art. no. 9001 1120

Fiber Light Colour S  
75 W with 9 light points (1 x 0.5 m, 2 x 1 m, 3 x 1.6 m, 2 x 1.9 m, 1 x 2.3 m) and a rotating disc for fixed or changing colours.  
Art. no. 9001 1125

Fiber Light Colour  
75 W, as above but with 9 light points on 2.5 m cables for large rooms.  
Art. no. 9001 1130

### 3. Downlights

Effective spotlighting angled down in, for example, a soffit outside the sauna (not suitable for use inside the sauna). 12 V/10 W. Connect to 12 V transformer.

4. Downlight 57mm  
Installation size:  $\varnothing$  57 mm. IP 21.  
Art. no. 9001 1083

5. Downlight 60mm  
Installation size:  $\varnothing$  60 mm. IP 44.  
Art. no. 9001 1082

6. Downlight 74mm  
Installation size:  $\varnothing$  74 mm. IP 21.  
Art. no. 9001 1085

7. Downlight 78mm  
Installation size:  $\varnothing$  78 mm. IP 44.  
Art. no. 9001 1087

1

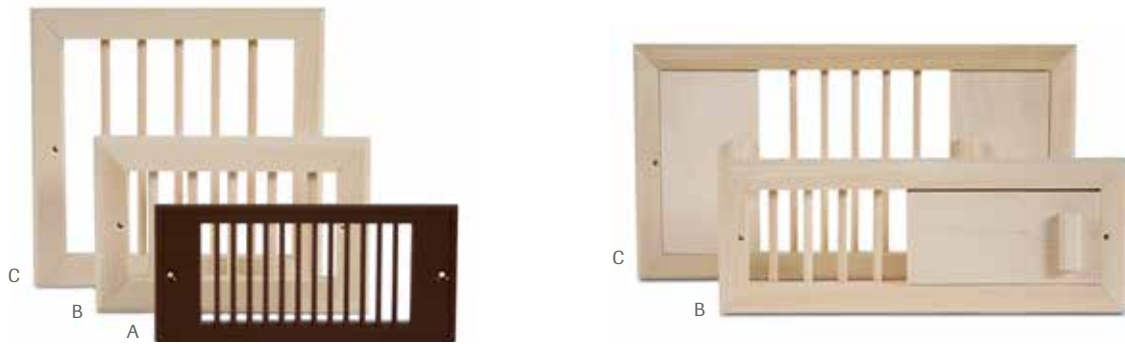

2



3



4



5



6

## 1. Ventilation

### Ventilation grille A

Located on the outside of the air inlet/outlet. Size 10 x 22 cm (Installation size 8 x 16 cm).

Art. no. 9017 1000

### Ventilation grille B

Size 14 x 22 cm.

Aspen Art. no. 9018 1040

Al Art. no. 9018 1038

### Ventilation grille C

for sauna rooms over 25 m<sup>3</sup> in volume. Vent opening 300 cm<sup>2</sup>. Size 24.5 x 25.5 cm.

Aspen Art. no. 9018 1032

### Vent hatch B

Fits over the air outlet inside the sauna to regulate air flow. Size 14 x 37,5 cm.

Aspen Art. no. 9018 1036

Alder Art. no. 9018 1034

### Vent hatch C

for sauna rooms over 25 m<sup>3</sup> in volume. Adjustable opening 0-300 cm<sup>2</sup>. Size: 24.5 x 45.5 cm.

Asp Art. no. 9018 1030

## 2. Heater guards

### Heater guard 6-8 V

Wall-mounted design for heaters 6.6-8 kW.

Art. no. 9000 1002

### Heater guard 10-20 V

As above, for heaters 10.7-20 kW.

Art. no. 9000 1012

### Heater guard 6-8 H

Corner-mounted design for heaters 6.6-8 kW.

Art. no. 9000 1003

### Heater guard 10-20 H

As above, for heaters 10.7-20 kW.

Art. no. 9000 1013

## 3. Automatic door-closer

Fits on the hinge side of the door.

Closes from a fully open position. For controlled closure, add the hydraulic shutting device described below.

Art. no. 9030 1030

## 4. Shutting device

For controlled closure of your door.

The perfect complement to the above door-closer.

### Shutting device, wooden doors

Art. no. 9030 1000

### Shutting device, glass doors

Art. no. 9030 1010

## 5. Threshold

Wooden threshold for subsequent installation. Suitable for DGB and DGL doors with door widths 7 and 8. Available in spruce and aspen. Size: 30 x 92 mm.

### Threshold DGB width 7 spruce

Art. no. 9103 1560

### Threshold DGL width 7 aspen

Art. no. 9103 1561

### Threshold DGB width 8 spruce

Art. no. 9103 1565

### Threshold DGL width 8 aspen

Art. no. 9103 1566

## 6. Strip package

The strip package contains three strips, measuring 12 x 43 x 2400 mm, in clean, light aspen. Suitable e.g. as a door lining, internal or external ceiling strip, etc.

Art. no. 9103 1575

## This is how to keep your sauna fresh.

To get the most enjoyment out of and in your sauna, you should devote a little time to maintenance now and then. Below are a few tips on how to keep your sauna clean and fresh using simple means – and at the same time increase both the service life of the sauna and your own enjoyment.

### Surface treatment

Apply several layers of boat varnish on the threshold and door handles, as well as on the wooden floor, floor rack or step (if present). This safeguards the wood's finish, at the same time as providing you with a beautiful, dirt-repellent surface that always retains its freshness.

It is recommended that sauna benches, backrests and skirting panels are oiled on both sides with Tylö sauna oil. This odourless treatment makes cleaning easier and produces a water-repellent surface. **IMPORTANT!** Internal walls and ceiling must not be treated.

If the sauna has been fitted with glass windows or walls, it is advisable to treat the lower strips that rest against the glass with extra care. Condensation often forms here, which can damage the wood. Apply boat varnish to the exposed sections or repeat the oil treatment at more frequent intervals.

### Cleaning

To achieve the maximum possible return from your sauna, it is important to keep it clean and attractive. You should therefore clean the sauna regularly, scrubbing the benches and the floor. Use normal soft soap, which is a mild and gentle detergent and which also has a pleasant, old-fashioned fragrance.

### Thermometer and hygrometer

In order to produce accurate readings, these must be located on a side wall in relation to the heater and 1500 mm above the floor.

### Wooden bucket and ladle

Tylö's wooden buckets have a plastic insert that prevents dry cracking after use. The bucket should be kept as cool as possible, ideally down on the floor and never on the upper benches.

In order to preserve the bucket and ladle, we recommend that you treat the wood with Tylö's sauna oil from time to time.

### Sauna stones

The sauna stones must be of diabase or olivine, two types that can withstand both significant heating and rapid cooling. It is important for the stone compartment to be filled in the correct way. Take care to follow the instructions in the installation instructions supplied on delivery of your Tylö heater.

### Check the stone compartment

You should do this a couple of times a year – especially if you use the sauna frequently. Proceed as follows: Remove all the stones from the compartment. Vacuum up small stones and gravel, and clean any calcium deposits from the bottom of the stone compartment. Return any stones that are in good condition and replace all cracked stones with new ones.

### Birch brush

The best time for making a birch brush is in the early summer, when the leaves are just the right size and are still free from inhabitants. Bind the brush in a large bouquet measuring 50–60 cm in length. At the same time, make a loop at the end so that it can be hung on the wall. Store the brush dry in a dark, cool place. You can also place it in a plastic bag and store it in the freezer.

When the brush is to be used, first allow it to thaw out in lukewarm water before pouring water over it above the heater's stone compartment. This will make the birch brush like new again, with a wonderful fragrance and perfect for fanning your body. This feeling, of being able to take out a birch brush in the middle of winter that still retains the wonderful fragrance of summer, is delightful.

### Other invigorating scents in the sauna

Feel free to hang a bundle of juniper twigs from the wall of your sauna. They look decorative and give off a wonderful fragrance that remains for a long time. A few drops of Tylö sauna fragrance in the water that you pour over the stones gives a refreshing and pleasant sensation in your nose and airways. Tylö sauna fragrance is a pure, natural product and is available in several pleasant scents, such as eucalyptus, peppermint and lavender.



## 1. Hygiene

### Solvent

Powder for descaling the water tank in Tylö Combi heaters and Tylö steam generators. Totally odourless and harmless. Sold in 5 kg packs.

Art. no. 9090 3000

### Solvent 50

As above, in large pack of 50.

Art. no. 9090 3007

### Solvent Sulfamic

An extremely effective descaling agent for professional use only in public facilities. Sold in 5 kg packs.

Art. no. 9090 3010

### Sauna oil

For treating benches and other wood surfaces in the sauna. Makes cleaning easier and gives a water-repellent surface. 1 litre plastic bottle (for approx. 6 m<sup>2</sup>).

Art. no. 9002 2050

## 2. Cleansing Kit

Removes calcium deposits on shower glass and glazed tiles. Always use the titanium wool ball with plenty of water. Impregnating liquid to protect shower glass and glazed tiles against a build-up of calcium deposits.

Art. no. 9090 3020

### Tylö Impregnator

Preserves and protects shower glass and glazed tiles. Spray on and rinse

off with clean water.

Art. no. 9090 3030

### Disinfectant

For effective disinfecting of sauna rooms. 5 litre plastic containers.

Art. no. 9002 9100



# Infra

## About Pure Infra Cabin

The integral infra panels in Tylö's Prime infra cabins emit invigorating long-wave infrared heat. The pleasant infrared heat is based on the CarbonFlex heating system, whose large infra panels guarantee an even distribution of heat across the benches, walls and floor.

The CarbonFlex heating system is built on tried-and-tested technology that delivers superior safety and performance.





# The healthiest infrared available anywhere

All infrared delivery systems produce EMR and EF to some extent. While the levels are typically low, it is still not clearly understood what the long term effects of low exposure might mean. Pure Infra technology was developed to take the worry out of unnecessary exposure to EMR and EF. For instance, the electrical field in a Pure Infra is less than you'd experience from a computer screen or cell phone. After all, if the point is to detoxify, why expose yourself to any level of unnecessary radiation?

## Better for everyone

Pure Infra cabins heat quickly and efficiently with a tap of the touchscreen control. A Pure Infra cabin also heats up near-instantly to your set comfort level while using up to 20% less energy than other systems. That means fewer energy resources are used to provide the safest, most comforting infrared heat bathing experience available— and that's better for everyone.



## Full-body heat

The exclusive Even Heat system includes oversized heating panels that ensure infrared waves warm every part of your body evenly—as well as a gentle heat-redistribution system that spreads heat more evenly throughout the cabin. With Even Heat there are no “cold spots” from heat stratification—you are bathed evenly in the safest infrared available from every angle, floor to ceiling.



**CarbonFlex®**





## Music to your ears

Every Pure Infra cabin model includes a speakerless, touch-screen-operated sound system that provides crystal clear pleasure from your favorite MP3's or the radio. With no visible speakers, the interior finishing is even less cluttered—adding another touch of comfort to your daily detox.



## Easy on the eyes

Pure Infra cabins include tri-modal lighting systems, with soft valance lighting, ceiling reading lights and colour light therapy. This allows you to relax in the soft and diffuse valance lighting, use color to create an energizing ambiance, or simply enjoy your favorite magazine or book without straining.



## The Lowest EMR + EF available

Simply put, no other infrared cabin system minimizes your exposure to EMR and EF better than Pure Infra. Our exclusive patent-pending technology means Pure Infra cabins produce less EMR and EF than sanctioned by Sweden's radiation standards—the toughest in the world.



Find out more at  
[www.tylo.com](http://www.tylo.com)



## Healthier infrared for all

Whatever your taste, budget or space challenges, there is a Pure Infra system for you. Regardless of layout model, Pure Infra cabins have a modern aesthetic with full glass fronts and include an intuitive touchscreen control system that makes heat, light and sound adjustment simplicity itself. Your Pure Infra cabin is delivered ready for easy assembly, and powered from a household outlet—just plug it in and you're ready to relax and detox in the comfort of your own home.

### Prime+ 99

- 1-person
- 914 x 914 x 1940 (mm) (WxDxH)

Art. no. 9510 9700

### Prime+ 1210

- 2-person
- 1219 x 1016 x 1940 (mm) (WxDxH)

Art. no. 9510 9710

### Prime+ 1611

- 3-person
- 1626 x 1118 x 1940 (mm) (WxDxH)

Art. no. 9510 9720

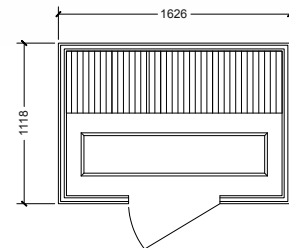
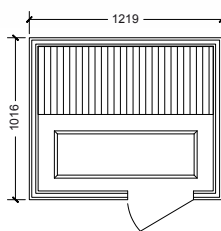
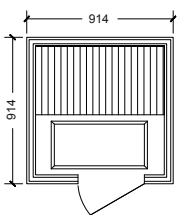

## All Pure Infra cabins include:

- By far the lowest EMR/EF of any infrared bathing system —beats even Sweden's tough standards.
- Exclusive EvenHeat technology—warms quickly and evenly with no "cold" spots.
- Finishing in clear Canadian Hemlock for its sturdy quality and beauty.
- Prefabricated panels for fast assembly with no tools —you can enjoy the full detox and relaxation benefits of your Pure Infra cabin within an hour of delivery.
- Full glass fronts and tempered, top quality floor to ceiling glass doors.

## Prime+ 1811

- 3-person
  - 1829 x 1118 x 1940 (mm) (WxDxH)
- Art. no. 9510 9730

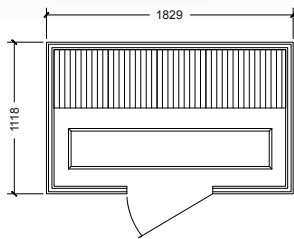

## Prime+ 1814

- 4-person
  - 1829 x 1422 x 1940 (mm) (WxDxH)
- Art. no. 9510 9740

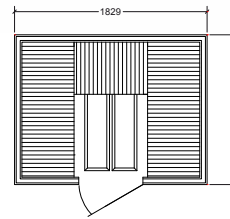

## Prime+ 1313/c

- 3-person
  - 1321 x 1321 x 1940 (mm) (WxDxH)
- Art. no. 9510 9750

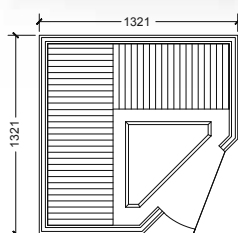

## Prime+ 1515/c

- 4-person
  - 1524 x 1524 x 1940 (mm) (WxDxH)
- Art. no. 9510 9760

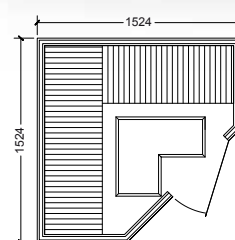



TYLÖ  
**SAUNA**  
**INFRA-RED SAUNA**  
**CABINS**

© 2013 Tylö AB.

Tylö AB accepts no responsibility for printing errors  
and reserves the right to make changes.

Produced by Markenvard Media and  
printed by Sörmlands grafiska.





Tylö dealers